



LAPAROSCOPIC
SURGERY

AESCULAP® SINGLE USE PRODUCTS

ENDOSCOPIC INSTRUMENTS AND ACCESSORIES

ENDOSKOPISCHE INSTRUMENTE UND ZUBEHÖR

All Aesculap endoscopy products can be found on our website:



Alle Aesculap Endoskopie Produkte finden Sie im Internet unter:



...just a click away!

CONTENT - INHALT

Indication-Kits: Appendectomy / Cholecystectomy Indikations-Kits: Appendektomie / Cholezystektomie	4
Advanced Bipolar Seal and Cut Technology Fortschrittliche Bipolare Gefäßversiegelung	6
Laparoscopic Instruments – monopolar / bipolar Laparoskopische Instrumente – monopolar / bipolar	8
Trocar Solution Trokar System	22
Ligation Clips and Appliers Ligatur-Clips und Anlegezangen	30
Dilatation Balloon Dilatationsballon	42
Suction-Irrigation – Accessories Saug- und Spülsysteme – Zubehör	44
Insufflation Systems – Accessories Insufflationssysteme – Zubehör	54
Retrieval Bags Bergebeutel	56
Visual System – Accessories Visuelles System – Zubehör	58
HF-Surgery – Accessories HF-Chirurgie – Zubehör	64
Single Use Surgical Instruments Chirurgische Einmalinstrumente	70

INDICATION-KITS: APPENDECTOMY / CHOLECYSTECTOMY

INDIKATIONS-KITS: APPENDEKTOMIE / CHOLEZYSTEKTOMIE



Indication-Kit

- Instant availability: Reduction of lead time for preparation
- Error reduction during preparation of the operation
- Simplification of warehousing
- Procedure-related cost transparency
- Waste reduction



Indikations-Kit

- Sofort einsetzbar: Reduzierung der Vorbereitungszeit
- Fehlerreduzierung in der Operationsvorbereitung
- Vereinfachung der Lagerhaltung
- Eindeutige, fallbezogene Kostentransparenz
- Abfallreduzierung

ENDOKIT-01000DE

Indication-Kit: Appendectomy
Indikations-Kit: Appendektomie



ENDOKIT-01001SE

Indication-Kit: Cholecystectomy
Indikations-Kit: Cholezystektomie



ENDOKIT-01000DE**INDICATION-KIT: APPENDECTOMY
INDIKATIONS-KIT: APPENDEKTOMIE**

1 x	EJ995	Insufflation needle, 120 mm, diam. 2.1 mm Insufflationsnadel, 120 mm, Ø 2,1 mm
1 x	PG012	Insufflation tube with hydrophobic CO ₂ filter Insufflationsschlauch mit hydrophobem CO ₂ -Filter
2 x	EK002SU	Sealing unit for trocars diam. 10 / 12 mm Universal-Dichteinheit für Trokare Ø 10/12 mm
1 x	EK001SU	Sealing unit for trocars diam. 5 mm Dichteinheit für Trokare Ø 5 mm
1 x	PL475SU	DS Appendectomy-Clips, X-Large, with latch, 4 Clips DS Appendektomie-Clips, X-Large, mit Zahn, 4 Clips
1 x	EJ022SU	Retrieval bag with memory wire, 210 ml Bergebeutel mit Memorydraht, 210 ml

Clinical use requires reusable trocar sleeves, trocar pins and a laparoscopic DS-Clip applier.

Zum klinischen Einsatz werden wiederverwendbare Trokarhülsen, Trokardorne sowie eine laparoskopische DS-Clip Anlegezange benötigt.

ENDOKIT-01001SE**INDICATION-KIT: CHOLECYSTECTOMY
INDIKATIONS-KIT: CHOLEZYSTEKTOMIE**

1 x	PL569T	Challenger® Ti Ligation Clips, Medium-Large, 8 Clips Challenger® Ti Ligatur Clips, Medium-Large, 8 Clips
2 x	EK117SU	Trocar sleeve (threaded, without stopcock) and sealing unit, diam. 5 mm, 110 mm Trokarhülse (mit Gewinde, ohne Hahn) und Dichteinheit, Ø 5 mm, 110 mm
1 x	EK149SU	Dilating trocar pin, diam. 5 mm, 110 mm Dilatations-Trokardorn, Ø 5 mm, 110 mm
1 x	EK226SU	Trocar set, consisting of trocar sleeve (threaded, with stopcock), sealing unit and dilating trocar pin, diam. 10 mm, 110 mm Trokar Set, bestehend aus Trokarhülse (mit Gewinde und Hahn), Dichteinheit und Dilatations-Trokardorn, Ø 10 mm, 110 mm
1 x	EK126SU	Trocar sleeve (threaded, with stopcock) and sealing unit, diam. 10 mm, 110 mm Trokarhülse (mit Gewinde und Hahn) und Dichteinheit, Ø 10 mm, 110 mm
1 x	EJ023SU	Detachable retrieval bag, 260 ml Abwerfbarer Bergebeutel, 260 ml
1 x	PG036SU	Suction / irrigation tubing with handle and cannula, diam. 5 mm, 330 mm Saug- / Spülschlauch mit Handgriff und Rohr, Ø 5 mm, 330 mm

Clinical use requires a reusable Challenger Clip Applier.

Zum klinischen Einsatz wird ein wiederverwendbarer Challenger Clip Applikator benötigt.

Caiman® - ADVANCED BIPOLAR SEAL & CUT TECHNOLOGY

Caiman® - FORTSCHRITTLICHE BIPOLARE GEFÄSSVERSIEGELUNG



Caiman®

- **One seal confidence**
Vessel sealing with only one energy activation.
- **Uniform tissue compression**
Leads to consistent sealing quality from distal to proximal tip.
- **Tip first closure**
Retains tissues within the jaws for improved compression.
- **Long jaw tip**
Enlarged vessel sealing length and improved surgical efficiency.
- **80 degree articulation jaw**
Allows simplified navigation in challenging anatomy.

Caiman®

- **Effektive Gefäßversiegelung**
Hohe Qualität der Gefäßversiegelung bei einmaliger Energie-Aktivierung.
- **Gleichmäßige Gewebekompression**
Reproduzierbare hohe Qualität der Gefäßversiegelung.
- **Distales Schließen der Instrumentenspitze**
Gleichmäßige Gewebekompression und präzise Gefäßpositionierung.
- **Lange Instrumentenspitzen**
Erhöhte Versiegelungslänge und verbesserte chirurgische Effizienz.
- **80° Abwinklung**
Vereinfachte Navigation in schwierigen anatomischen Verhältnissen.

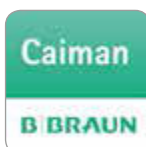

For further information see our brochure C90202, Caiman App or by visiting www.bbraun.com/caiman

Weitere Informationen finden Sie in unserem Prospekt, in unserer Caiman App und auf www.bbraun.com/caiman

AESCLAP® Caiman®

	Shaft diameter Schafstdurchmesser	Working length Arbeitslänge	Pcs. per pack Stück pro Packung
--	--------------------------------------	--------------------------------	------------------------------------

Caiman® 5, non articulating jaw
Caiman® 5, nicht abwinkelbare Spitze

PL718SU* / PL738SU**	5 mm	24 cm	6
PL720SU* / PL740SU**	5 mm	36 cm	6
PL722SU* / PL742SU**	5 mm	44 cm	6



Caiman® 5, articulating jaw
Caiman® 5, abwinkelbare Spitze

PL719SU* / PL739SU**	5 mm	24 cm	6
PL721SU* / PL741SU**	5 mm	36 cm	6
PL723SU* / PL743SU**	5 mm	44 cm	6



Caiman® 12, articulating jaw
Caiman® 12, abwinkelbare Spitze

PL730SU	12 mm	24 cm	3
PL731SU	12 mm	44 cm	3



Lektrafuse RF-Generator (without main cable)
Lektrafuse HF-Generator (ohne Netzkabel)

GN200



* Ordering number for the following countries / Bestellnummer für folgende Länder:
CN, KR, BR, JP, RU, CO, MY, SG, AR, EC, TW

** Ordering number for the following countries / Bestellnummer für folgende Länder:

UK, DE, FR, ES, PL, IT, SE, CZ, NL, BE, LU, PT, AT, CH, BA, DK, FI, IE, SK, NO, TR, HU, RO, BG, CY, SI, GR, KZ, US, ID, PH, AU, NZ,
HK, MX, PE, AZ, CL, JO, KW, LY, NC, IN, BO

AdTec® MINI SINGLE USE INSTRUMENTS

AdTec® MINI SINGLE USE INSTRUMENTE



AdTec® mini single use

- Ergonomic handle with large contact surface for fingers
- One-to-one tactile feedback
- Shaft 360° rotatable
- Integrated overload protection in handle
- No protruding joints distally
- Insulated up to the jaws
- Pack containing 5 pieces

AdTec® mini single use

- Ergonomischer Handgriff mit großer Auflagefläche für die Finger
- Gute Taktilität
- Schaft 360° drehbar
- Integrierter Überlastschutz im Handgriff
- Keine austretende Gelenke
- Isolierung bis an die Maulteile
- Packung á 5 Stück

			Diam. Ø	Length Länge
--	--	--	------------	-----------------

METZENBAUM scissors
METZENBAUM Schere

PO830SU

- Good cutting properties
- Tips curved to the left

- Gute Schneideigenschaften
- Blätter nach links gebogen

3.5 mm

290 mm



MARYLAND grasping and dissecting forceps
MARYLAND Fass- und Präparierzange

PO831SU

- Precise grasping and dissection of tissue

- Präzises Fassen und Präparieren des Gewebes

3.5 mm

290 mm

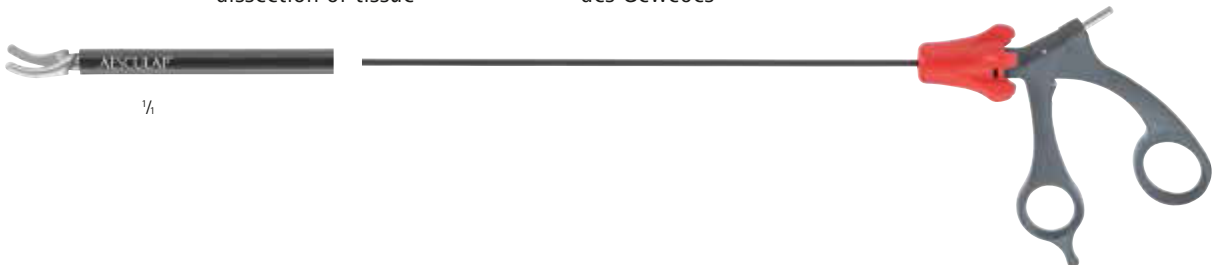

Atraumatic universal grasping forceps
Atraumatische Fasszange

PO833SU

- Fenestrated jaw
- Precise grasping of tissue
- Handle with ratchet ratchet can be deactivated

- Gefenstertes Maul
- Präzises Fassen des Gewebes
- Griff mit Sperre Sperre deaktivierbar

3.5 mm

290 mm

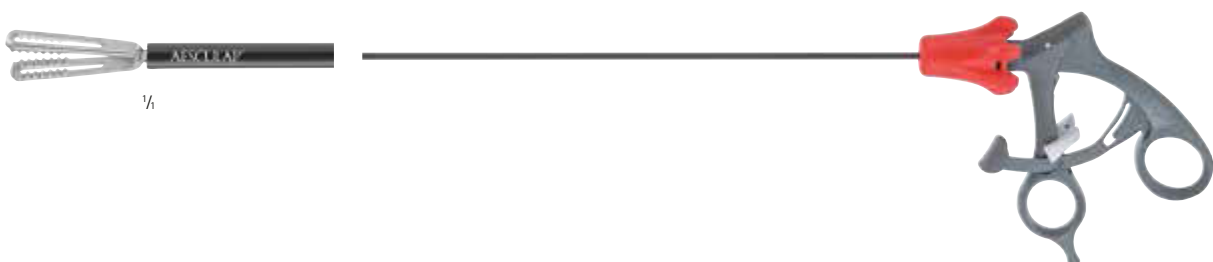

AdTec® SINGLE USE MONOPOLAR INSTRUMENTS

AdTec® SINGLE USE MONOPOLARE INSTRUMENTE



Monopolar single use instruments

- Insulated up to the jaws
- Ergonomic handle with large contact surface for fingers
- One-to-one tactile feedback
- Shaft 360° rotatable
- Pack containing 5 pieces

Monopolare Einmalinstrumente

- Isolierung bis an die Maulteile
- Ergonomischer Handgriff mit großen Auflageflächen für die Finger
- Gute Taktilität
- Schaft 360° drehbar
- Packung à 5 Stück

		Diam. Ø	Length Länge
--	--	------------	-----------------

METZENBAUM scissors
METZENBAUM Schere

PO840SU	<ul style="list-style-type: none"> ■ Good cutting properties ■ Tips curved to the left 	<ul style="list-style-type: none"> ■ Gute Schneideigenschaften ■ Blätter nach links gebogen 	5 mm	310 mm
---------	--	---	------	--------



MARYLAND grasping and dissecting forceps
MARYLAND Fass- und Präparierzange

PO841SU	<ul style="list-style-type: none"> ■ Precise grasping and dissection of tissue 	<ul style="list-style-type: none"> ■ Präzises Fassen und Präparieren des Gewebes 	5 mm	310 mm
---------	---	---	------	--------



AdTec® SINGLE USE MONOPOLAR INSTRUMENTS

AdTec® SINGLE USE MONOPOLARE INSTRUMENTE

			Diam. Ø	Length Länge
<p>Pike-mouth forceps Hechtmaul Faszange</p>				
P0842SU	<ul style="list-style-type: none"> ■ Precise grasping of tissue ■ Handle with ratchet / ratchet can be deactivated 	<ul style="list-style-type: none"> ■ Präzises Fassen des Gewebes ■ Griff mit Sperre / Sperre deaktivierbar 	5 mm	310 mm
				
<p>Atraumatic universal grasping forceps Atraumatische Faszange</p>				
P0843SU	<ul style="list-style-type: none"> ■ Fenestrated jaw ■ Precise grasping of tissue ■ Handle with ratchet / ratchet can be deactivated 	<ul style="list-style-type: none"> ■ Gefenstertes Maul ■ Präzises Fassen des Gewebes ■ Griff mit Sperre / Sperre deaktivierbar 	5 mm	310 mm
				

			Diam. Ø	Length Länge
--	--	--	------------	-----------------

BABCOCK tissue-grasping forceps
BABCOCK Organfasszange

PO844SU	<ul style="list-style-type: none"> Precise grasping of tissue Handle with ratchet / ratchet can be deactivated 	<ul style="list-style-type: none"> Präzises Fassen des Gewebes Griff mit Sperre / Sperre deaktivierbar 	5 mm	310 mm
---------	--	--	------	--------



BABCOCK tissue-grasping forceps
BABCOCK Organfasszange

PO845SU	<ul style="list-style-type: none"> Precise grasping of tissue Handle with ratchet / ratchet can be deactivated 	<ul style="list-style-type: none"> Präzises Fassen des Gewebes Griff mit Sperre / Sperre deaktivierbar 	10 mm	310 mm
---------	--	--	-------	--------



AdTec® SINGLE USE MONOPOLAR SHAFTS

AdTec® SINGLE USE MONOPOLARE SCHÄFTE



Monopolar single use shafts – scissors

- Combination of single use shaft and reusable handle e. g. P0958R
- Good cutting properties
- Insulated up to the scissors blades
- Increased flexibility in daily clinical use
- Economic price performance ratio
- Easy assembly – one click mechanism
- Shaft 360° rotatable
- Pack containing 10 pieces

Monopolare Einmalschäfte – Scheren

- Kombination von sterilem Einmalschaft mit wiederverwendbaren Griffen, z. B. P0958R
- Gute Schneideigenschaften
- Isolation bis an die Scherenblätter
- Erhöhte Flexibilität im klinischen Alltag
- Ökonomisches Preis-Leistungsverhältnis
- Einfache Adaption – One-Click-Prinzip
- Schaft 360° drehbar
- Packung à 10 Stück einzeln steril verpackt

reusable
wiederverwendbar

P0958R
Monopolar non-ratched handle
Monopolarer Handgriff ohne Sperre



		Diam. Ø	Length Länge
--	--	------------	-----------------

Scissors / Scheren

PO885SU	■ Scissors, tips slightly curved with fine tip	■ Schere, Blätter leicht gebogen mit feiner Spitze	5 mm	310 mm
---------	--	--	------	--------



PO886	■ Hook scissors	■ Hakenschere	5 mm	310 mm
-------	-----------------	---------------	------	--------



Mini-METZENBAUM

PO887	■ Scissors, tips curved to the left	■ Schere, Blätter nach links gebogen	5 mm	310 mm
-------	-------------------------------------	--------------------------------------	------	--------



METZENBAUM

PO888	■ Scissors, tips curved to the left	■ Schere, Blätter nach links gebogen	5 mm	310 mm
-------	-------------------------------------	--------------------------------------	------	--------



METZENBAUM

PO889	■ Scissors, tips curved to the left	■ Schere, Blätter nach links gebogen	5 mm	420 mm
-------	-------------------------------------	--------------------------------------	------	--------



AdTec® SINGLE USE MONOPOLAR SHAFTS

AdTec® SINGLE USE MONOPOLARE SCHÄFTE



Monopolar single use shafts – Forceps

- Combination of single use shaft and reusable handle, e. g. P0959R
- Precise grasping of tissue
- Insulated up to the jaws
- One-to-one tactile feedback
- Easy assembly – One-Click mechanism
- Shaft 360° rotatable
- Pack containing 10 pieces
- Economic price performance ratio
- Increased flexibility in daily clinical use



Monopolare Einmalschäfte – Faszangen

- Kombination von sterilem Einmalschaft mit wiederverwendbaren Griffen, z. B. P0959R
- Präzises Fassen des Gewebes
- Isolation bis an die Maulteile
- Gute Taktilität
- Einfache Adaption – one-click-Prinzip
- Schaft 360° drehbar
- Packung à 10 Stück einzeln steril verpackt
- Ökonomisches Preis-Leistungsverhältnis
- Erhöhte Flexibilität im klinischen Alltag

reusable
wiederverwendbar

P0959R
Monopolar handle with ratchet,
ratchet can be deactivated
Monopolärer Handgriff mit Sperre,
Sperre deaktivierbar

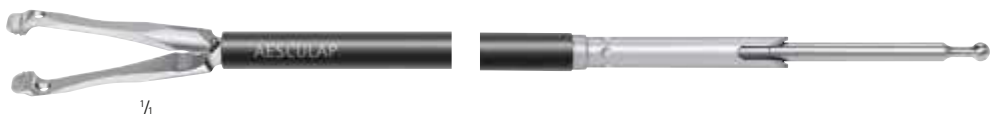

	Diam. Ø	Length Länge
<p>MARYLAND fixation and dissecting forceps MARYLAND Fass- und Präparierzange</p> <p>PO891SU</p>  <p>1/4</p>	5 mm	310 mm
<p>Pike-mouth forceps Hechtmaul Fasszange</p> <p>PO892SU</p>  <p>1/4</p>	5 mm	310 mm
<p>Atraumatic universal grasping forceps Atraumatische Universalfasszange</p> <p>PO893SU</p>  <p>1/4</p>	5 mm	310 mm
<p>BABCOCK tissue-grasping forceps BABCOCK Organfasszange</p> <p>PO894SU</p>  <p>1/4</p>	5 mm	310 mm

AdTec® SINGLE USE BIPOLAR INSTRUMENTS

AdTec® SINGLE USE BIPOLARE INSTRUMENTE







Bipolar single use instruments

- Good coagulation results
- No current leakage thanks to bipolar technology
- Jaw parts feature ceramic insulation
- Insulated up to the jaws
- Non-protruding joints
- Ergonomic handle design
- One-to-one tactile feedback
- Compatible to all electrosurgical units
- Shaft 360° rotatable
- Pack containing 6 pieces

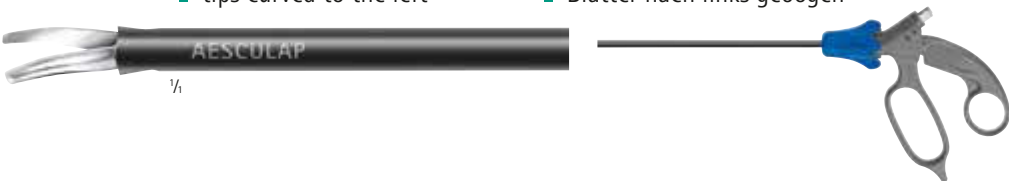
Bipolare Einmalinstrumente

- Gute Koagulationsergebnisse
- Keine Ableitströme durch bipolare Technik
- Keramikisolation im Maulbereich
- Isolation bis an die Maulteile
- Keine austretenden Gelenkteile
- Ergonomische Griffform
- Gute Taktilität
- Kompatibel zu allen Elektrochirurgie-Generatoren
- Schaft 360° drehbar
- Packung à 6 Stück

			Diam. Ø	Length Länge
METZENBAUM scissors METZENBAUM Scheren				
PL700	<ul style="list-style-type: none"> Good cutting properties tips curved to the left 	<ul style="list-style-type: none"> Gute Schneideigenschaften Blätter nach links gebogen 	5 mm	310 mm
				
MARYLAND fixation and dissecting forceps MARYLAND Fass- und Präparierzange				
PL701	<ul style="list-style-type: none"> Precise grasping and dissection of tissue, fenestrated 	<ul style="list-style-type: none"> Präzises Fassen und Präparieren des Gewebes, gefenstert 	5 mm	310 mm
				
PL702SU	<ul style="list-style-type: none"> Precise grasping and dissection of tissue 	<ul style="list-style-type: none"> Präzises Fassen und Präparieren des Gewebes 	5 mm	310 mm
				
MACRO grasping forceps MACRO Fasszange				
PL703SU			5 mm	310 mm
				
Bipolar single use cable Bipolares Einmalkabel			Pin distance Pinabstand	Length Länge
				4 m
GK290SU	Suitable for / Geeignet für:	Dolly, EMC, ERBE Int.	22 mm	
GK291SU	Suitable for / Geeignet für:	Aesculap, BOWA, EMC, Lamidey, Söring, Valleylab, ERBE ICC und VIO mit Adapter BOWA-340-000 (o. Abb.)	28.6 mm	
GK292SU	Suitable for / Geeignet für:	Codman (CMC II, CMC III)	38 mm	

AdTec® comBi SINGLE USE BIPOLAR INSTRUMENTS

AdTec® comBi EINMAL-INSTRUMENTE



Bipolar combination instrument for laparoscopy

AdTec® comBi is a combination instrument for laparoscopic surgery. It combines a bipolar grasping forceps with mechanical scissors.

The integrated functions allow:

- Precise dissection
- Reliable grasping and manipulation of tissue
- Bipolar coagulation
- Effective mechanical cutting

Further advantages

- Fine instrument tips for excellent overview
- Color coding for simple recognition of the active function (scissors or grasping forceps)
- "4 in 1" cost efficiency (grasping, dissecting, coagulating, cutting) – fewer instrument changes
- For single use
- Pack containing 6 pieces

Bipolares Kombinationsinstrument für die Laparoskopie

AdTec® comBi ist ein Kombinationsinstrument für laparoskopische Eingriffe. Es kombiniert eine bipolare Faszange mit einer mechanischen Schere.

Die integrierten Funktionen ermöglichen:

- Präzise Präparation
- Zuverlässiges Fassen und Manipulieren von Gewebe
- Bipolare Koagulation
- Mechanisches Schneiden

Weitere Vorteile

- Übersicht durch feine Instrumentenspitze
- Einfaches Erkennen der aktiven Funktion (Schere bzw. Faszange) durch Farbkodierung
- Kosteneffizienz durch „4 in 1“ (fassen, präparieren, koagulieren, schneiden), dadurch weniger Instrumentenwechsel
- Zum Einmalgebrauch
- Packung à 6 Stück

	Diam. Ø	Length Länge
--	------------	-----------------

Bipolar combination instrument
Bipolares Kombinationsinstrument

PO800SU

5 mm

310 mm



■ Ergonomic handle:
a trigger integrated into the handle allows fast and easy switching from the grasping forceps to the scissors function

■ Ergonomischer Handgriff:
Eine im Handgriff integrierte Taste erlaubt das einfache und schnelle Umschalten von der Faszangen- auf die Scherenfunktion

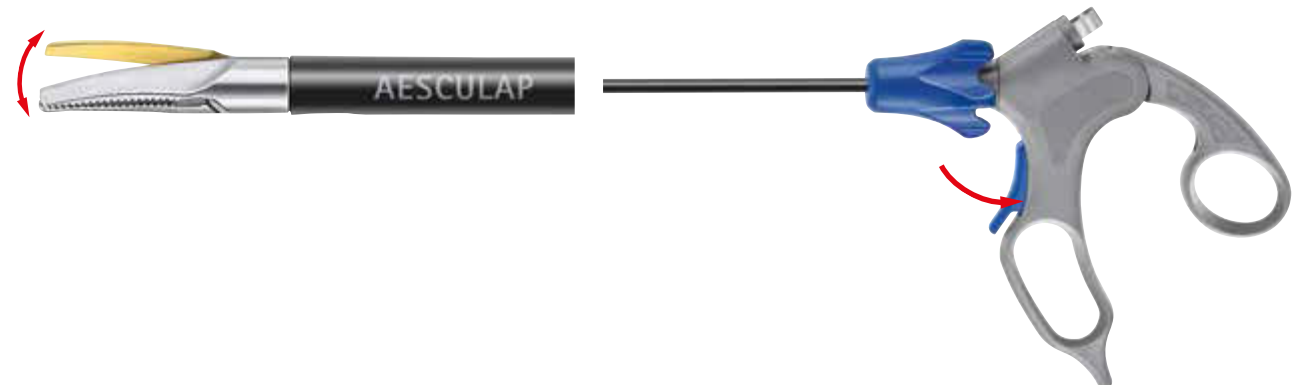

AESCULAP® SINGLE USE TROCAR SOLUTION

AESCULAP® SINGLE USE TROKAR SYSTEM



AESCULAP® single use trocar solution

- Convenient
Ease of use while meeting the functional needs of a trocar system.
- Space-saving, slender design.
- Reliable
Patient and user safety is a central requirement of the trocar system.
- Stability
Firm hold in the abdominal wall during instrument exchange and intraoperative work.
- Functionality
Sterile packaging, x-ray transparency and low weight increase operative utility.
- Flexibility
Universal seal, suitable for instruments with diameters of 5 - 12 mm, offers essential flexibility.

AESCULAP® single use Trokar System

- Komfortabel
Ein System mit einfacher Handhabung, das die Ansprüche an ein Trokar System erfüllt.
- Platzsparend
Schlankes Trokardesign.
- Zuverlässig
Die Patienten- und Anwendersicherheit ist eine der zentralen Anforderungen an das Trokar System.
- Stabilität
Guter Halt in der Bauchdecke beim Instrumentenwechsel sowie beim intraoperativen Arbeiten.
- Funktional
Sterile Bereitstellung, Röntgendurchlässigkeit und ein geringes Gewicht stehen exemplarisch für hohe Funktionalität.
- Flexibel
Universaldichtung für den Einsatz von Instrumenten mit einem Durchmesser von 5 - 12 mm.

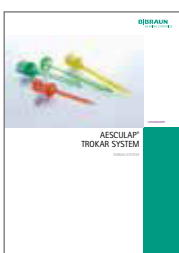

For further information see our brochure C90402 AESCULAP® single use trocar solution.

Weitere Informationen finden Sie in unserem Prospekt C90401 AESCULAP® single use Trokar System.

Diam. 5 mm Trocar Set, consisting of: trocar sleeve, sealing unit, dilating trocar pin
Ø 5 mm Trokar Set, bestehend aus: Trokarhülse, Dichteinheit, Dilatations-Trokarhorn

1 Pack of 6 pieces

1 Pack à 6 Stück

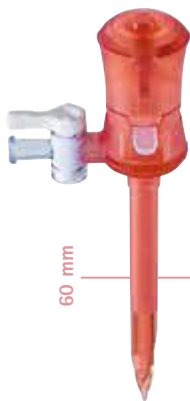

EK210SU
smooth, with stopcock 60 mm
glatt, mit Hahn 60 mm



EK212SU
threaded, with stopcock 60 mm
Gewinde, mit Hahn 60 mm



EK214SU
smooth, with stopcock 110 mm
glatt, mit Hahn 110 mm



EK216SU
threaded, with stopcock 110 mm
Gewinde, mit Hahn 110 mm



EK218SU
smooth, with stopcock 150 mm
glatt, mit Hahn 150 mm

AESCU LAP® SINGLE USE TROCAR SOLUTION

AESCU LAP® SINGLE USE TROKAR SYSTEM

Diam. 5 mm single use trocar sleeves, consisting of: trocar sleeve and sealing unit
 Ø 5 mm Einmal-Trokarhülsen, bestehend aus: Trokarhülse und Dichteinheit

Diam. 5 mm single use trocar pins
 Ø 5 mm Einmal-Trokarborne

1 Pack of 6 pieces
 1 Pack à 6 Stück

1 Pack of 6 pieces
 1 Pack à 6 Stück

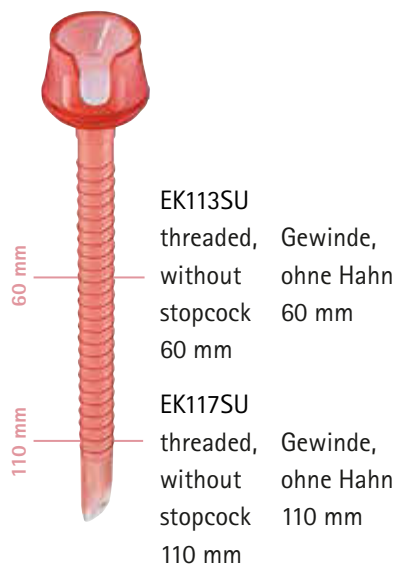
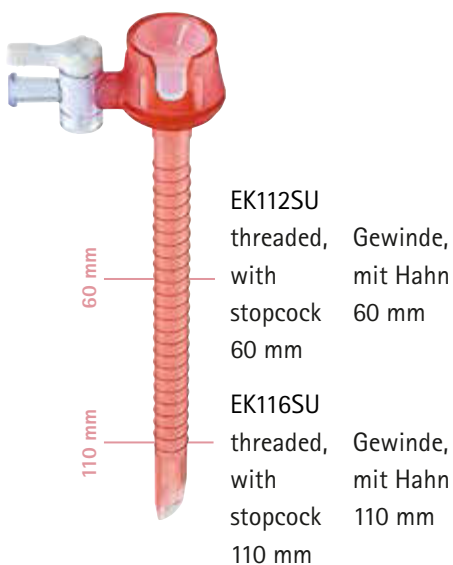
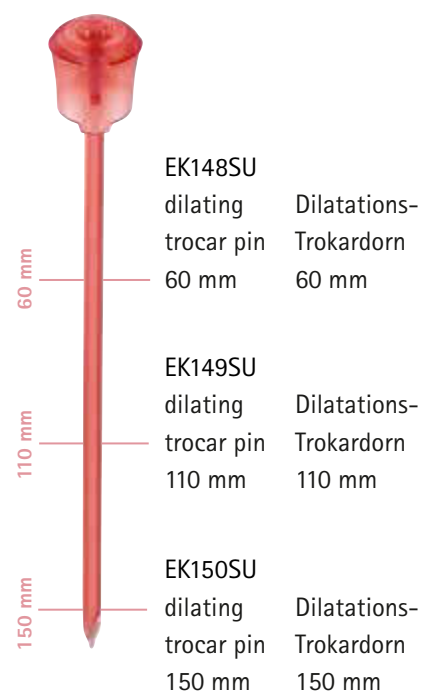
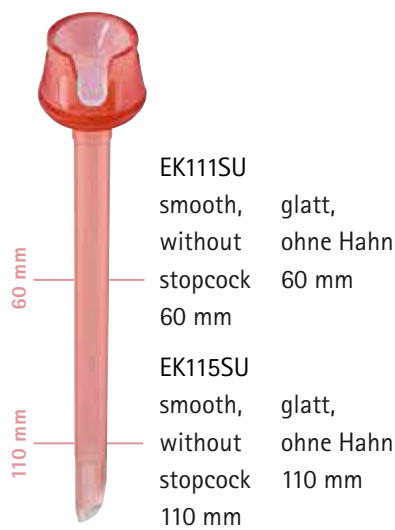
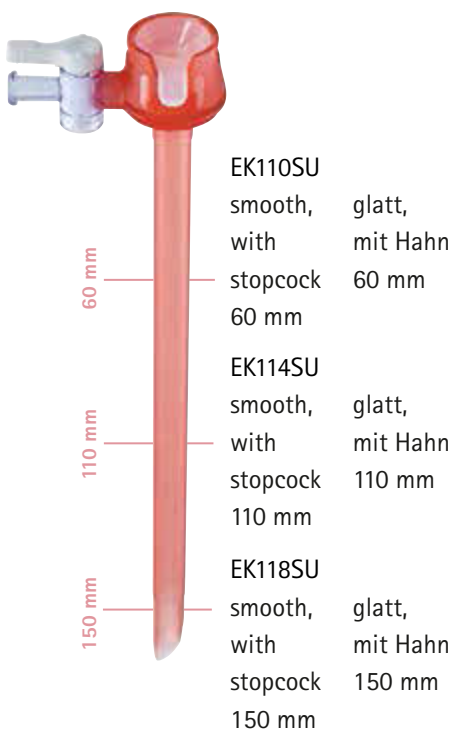

Diam. 10 mm Trocar Set, consisting of: trocar sleeve, sealing unit, dilating trocar pin
 Ø 10 mm Trokar Set, bestehend aus: Trokarhülse, Dichteinheit, Dilatations-Trocardorn

1 Pack of 6 pieces
 1 Pack à 6 Stück



EK224SU
 smooth, with stopcock 110 mm
 glatt, mit Hahn 110 mm



EK226SU
 threaded, with stopcock 110 mm
 Gewinde, mit Hahn 110 mm



EK228SU
 smooth, with stopcock 150 mm
 glatt, mit Hahn 150 mm

Diam. 10 mm single use trocar sleeves, consisting of: trocar sleeve and sealing unit
 Ø 10 mm Einmal-Trokarhülsen, bestehend aus: Trokarhülse und Dichteinheit

1 Pack of 6 pieces
 1 Pack à 6 Stück

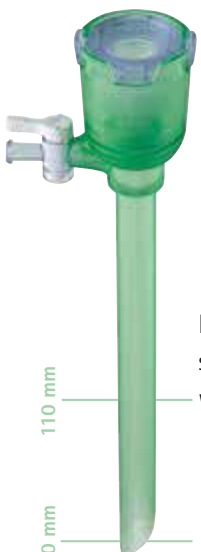

EK124SU
 smooth, with stopcock 110 mm
 glatt, mit Hahn 110 mm



EK126SU
 threaded, with stopcock 110 mm
 Gewinde, mit Hahn 110 mm



EK159SU
 dilating trocar pin 110 mm
 Dilatations-Trocardorn 110 mm



EK128SU
 smooth, with stopcock 150 mm
 glatt, mit Hahn 150 mm

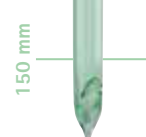

EK160SU
 dilating trocar pin 150 mm
 Dilatations-Trocardorn 150 mm

AESCU LAP® SINGLE USE TROCAR SOLUTION

AESCU LAP® SINGLE USE TROKAR SYSTEM

Diam. 12 mm Trocar Set, consisting of: trocar sleeve, sealing unit, dilating trocar pin
 Ø 12 mm Trokar Set, bestehend aus: Trokarhülse, Dichteinheit, Dilatations-Trokardorn

1 Pack of 6 pieces
 1 Pack à 6 Stück

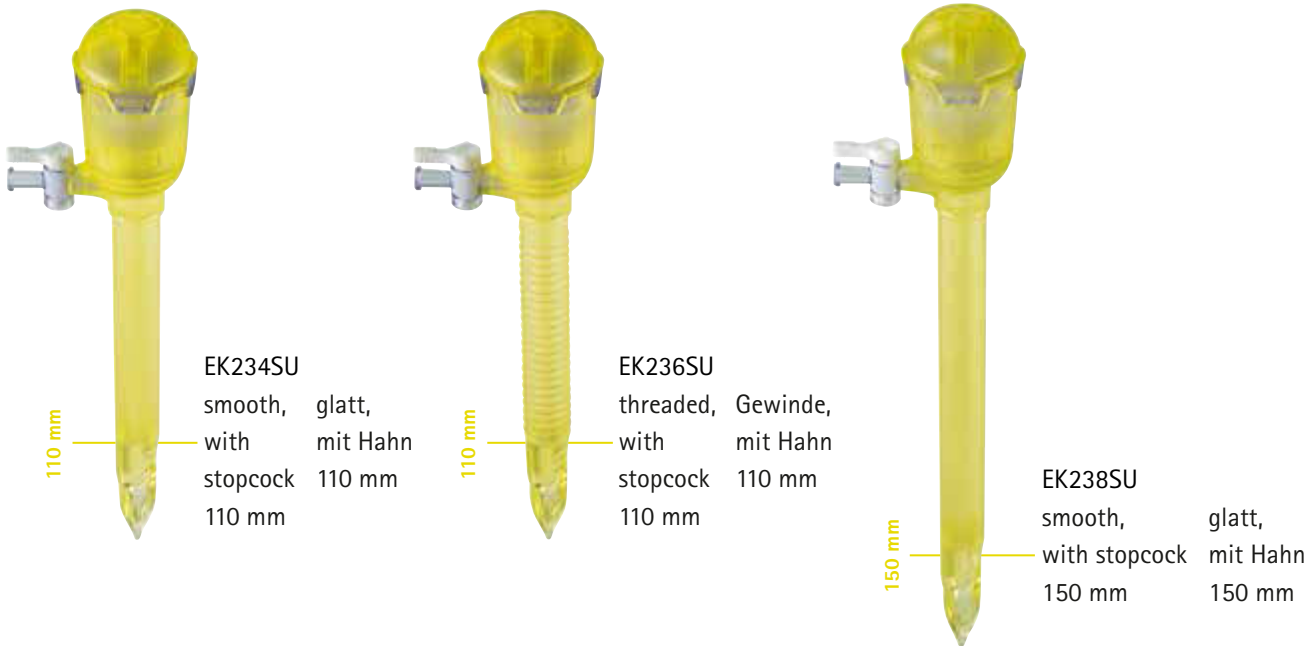

Diam. 12 mm single use trocar sleeves, consisting of: trocar sleeve and sealing unit
 Ø 12 mm Einmal-Trokarhülsen, bestehend aus: Trokarhülse und Dichteinheit

1 Pack of 6 pieces
 1 Pack à 6 Stück

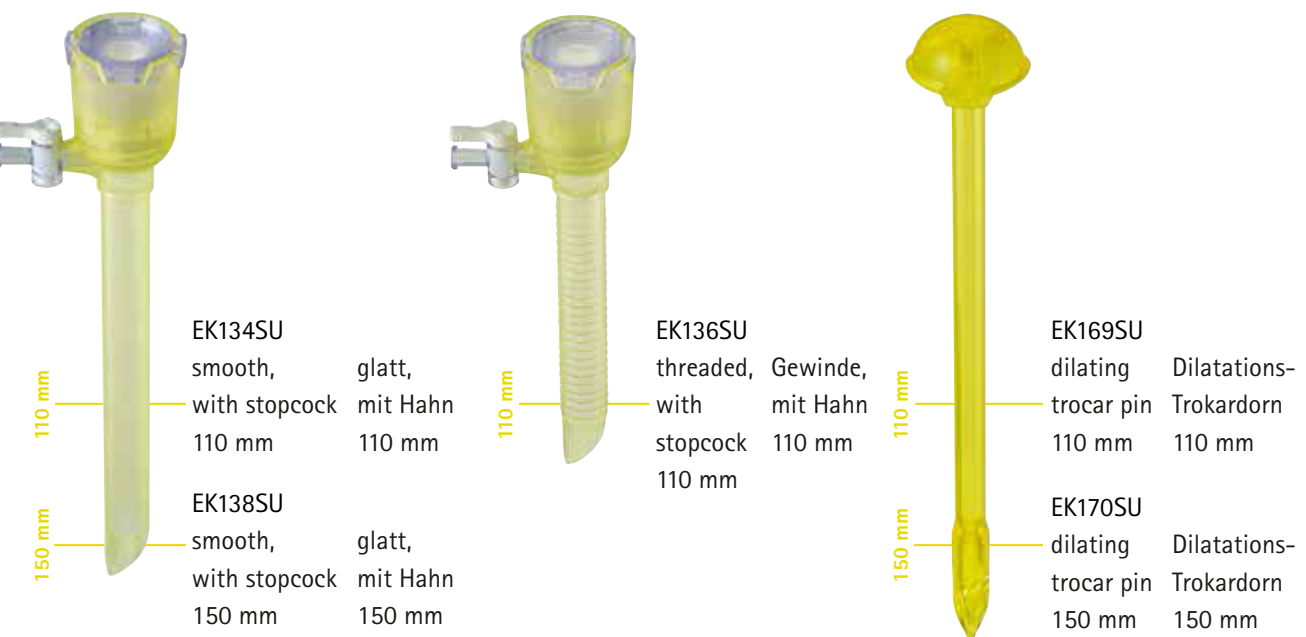

Single use HASSON Sets, consisting of: trocar sleeve, sealing unit, blunt trocar pin, cone
 Einmal HASSON Sets, bestehend aus: Trokarhülse, Universal-Dichteinheit, Trokardorn stumpf, Konus

1 Pack of 6 pieces
 1 Pack à 6 Stück



EK230SU
 HASSON
 trocar set
 10 mm
 HASSON
 Trokar Set
 10 mm



EK240SU
 HASSON
 trocar set
 12 mm
 HASSON
 Trokar Set
 12 mm

Sealing units
 Dichteinheiten



EK001SU
 Single use sealing unit
 for trocars diam. 5 mm
 1 Pack of 20 units
 Accommodates 5 mm
 instruments

Einmal Dichteinheit
 für Trokare Ø 5 mm
 1 Pack à 20 Stück
 Für 5 mm Instrumente



EK002SU
 Single use sealing unit
 for trocars diam. 10/12 mm
 1 Pack of 20 units
 Accommodates 5 - 12 mm
 instruments

Einmal Universal-Dichteinheit
 für Trokare Ø 10/12 mm
 1 Pack à 20 Stück
 Für 5 - 12 mm Instrumente

AESFULAP® MiniPort



AESFULAP® MiniPort

- Easy insertion
Handle design combined with a dilating tip for an accurate and targeted access of the trocar – less exertion necessary.
- Good fixation
Special profile on the trocar sleeve.
- Cost-effective
Combination of single use trocar and reusable dilating pin.

AESFULAP® MiniPort

- Einfaches Einbringen
Griffdesign gepaart mit Dilatationsspitze für einfaches Einbringen des Trokars – mit geringem Kraftaufwand.
- Gute Fixierung
Spezielle Profilierung der Trokarhülse.
- Wirtschaftlich
Kombination Einmaltrokar mit wiederverwendbarem Dilatationsdorn.

	Diam. Ø	Length Länge	Pcs. per pack Stk. pro Pack
MiniPort disposable trocar sleeve, with integrated seal and thread MiniPort Einmal-Trokarhülse mit Dichtung und Gewinde			
EK105SU	3.5 mm	70 mm	6



Dilating Trocar Pin - to be used with EK105SU
Dilatations Trokardorn - zur Verwendung mit EK105SU

EK030R

3.5 mm



reusable
wiederverwendbar

DS SINGLE FIRE TITANIUM LIGATION-CLIPS

DS SINGLE FIRE TITAN LIGATUR-CLIPS



DS Titanium Ligation-Clips: Innovative, reliable, convenient

Innovative: This system is innovative and unique in the segment of Titanium Ligation-Clips.

Reliable: The DS-Clip provides a firm hold on the clipped structure.

Convenient: The system is easy to use. It does not require an adaption of the order of operation.

- Material: titanium
- The DS-Clip has a clip shape with parallel arranged bars with a gap between which compresses the tissue. They stabilize the clip against axial dislodgement.
- The clip closes from the tip.
- A diamond-shaped inner clip profile leads to an enlarged contact surface with the tissue.
- Selective clip sizes are also available with latch, which additionally prevents the clip from slipping.











DS Titan Ligatur-Clips: Innovativ, zuverlässig, komfortabel

Innovativ: Das System ist innovativ und im Segment der Titan Ligatur-Clips einzigartig.

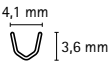
Zuverlässig: Der DS-Clip bietet einen sicheren Halt auf der geclippten Struktur.

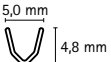
Komfortabel: Das System ist einfach anzuwenden. Es erfordert keine Änderung des Operationsablaufs.

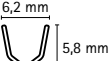
- Material: Reintitan
- Der DS-Clip verfügt über eine Clipform mit parallel angeordneten Stegen. Dadurch entsteht ein Zwischenraum, in dem das Gewebe verdichtet und das Risiko eines axialen Verschiebens reduziert wird.
- Der Clip schließt von der Spitze her.
- Durch die rautenförmige Innenprofilierung des Clips entsteht eine vergrößerte Kontaktfläche mit dem Gewebe.
- Ausgewählte Clipgrößen stehen ebenfalls mit Zahn zur Verfügung. Dieser stabilisiert den Clip zusätzlich gegen Herausrutschen von Gewebe.

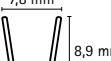
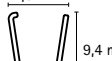
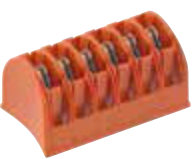
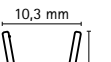
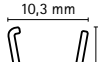
Size Größe	Color Code Farbmarkierung	Illustration, Clip without latch Abbildung, Clip ohne Zahn	Illustration, Clip with latch Abbildung, Clip mit Zahn	Clips p. cartridge Clips p. Magazin	No. of cart. p. pack Anz. Mag. p. Pack
					
Small		 4,1 mm 3,6 mm 1/1	PL450SU	6	15
			PL452SU (Multipack)	24	6
Small- Medium		 5,0 mm 4,8 mm 1/1	PL453SU	6	15
Medium		 6,2 mm 5,8 mm 1/1	PL459SU	6	15
Medium- Large Medium- Large (z)		 7,8 mm 8,9 mm 1/1	PL462SU	6	15
		 7,8 mm 9,4 mm 1/1	PL465SU		
Large Large (z)		 10,3 mm 12 mm 1/1	PL468SU	6	12
		 10,3 mm 12,6 mm 1/1	PL471SU		

DS SINGLE FIRE TITANIUM LIGATION-CLIPS

DS SINGLE FIRE TITAN LIGATUR-CLIPS



Clip Applicators

- Availability of laparoscopic and open-surgical applicators.
- The clip applicators are made with an integrated catch in order to reach a minimum force and simultaneously to avoid too excessive force.
- Laparoscopic clip applicator with rinsing channel for fast and safe cleaning.
- 360° rotatable shaft for accurate alignment of the clip.
- Well-known, proven and valued Aesculap quality.
- Color coding simplifies the identification of suitable clip applicators and cartridges.

Clip Anlegezangen

- Verfügbarkeit von laparoskopischen und offen-chirurgischen Anlegezangen.
- Integrierter Anschlag zum Erreichen einer Mindestkraft und gleichzeitigen Vermeidung einer übermäßigen Krafteinwirkung.
- Laparoskopische Anlegezange mit integriertem Spülkanal zur Reinigung.
- 360° drehbarer Schaft zur genauen Ausrichtung des Clips.
- Bekannte, bewährte und geschätzte Aesculap Qualität.
- Farbcodierung vereinfacht die Identifikation der passenden Clipgröße und Clip Anlegezange.

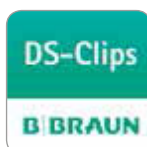

For further information
see our brochure C88011
or DS-Clip App.

Weitere Informationen
finden Sie in unserem
Prospekt C88011 oder in
unserer DS-Clip App.

At a glance Übersicht

	small	small-medium	medium	medium-large	large
DS Titanium Ligation-Clips DS Titan Ligatur-Clips	PL450SU (without latch / ohne Zahn)	PL453SU (without latch / ohne Zahn)	PL459SU (without latch / ohne Zahn)	PL462SU (without latch / ohne Zahn)	PL468SU (without latch / ohne Zahn)
	PL452SU (without latch / ohne Zahn, Multipack)			PL465SU (with latch / mit Zahn)	PL471SU (with latch / mit Zahn)
Clip Appliers for open surgery Clip Anlege- zangen für die offene Chirurgie	FC171R 150 mm, 25°	FC181R 150 mm, 25°	FC191R 150 mm, 25°	FC204R 190 mm, 25°	FC214R 190 mm, 25°
	FC174R 190 mm, 25°	FC184R 190 mm, 25°	FC194R 190 mm, 25°	FC205R 190 mm, 65°	FC215R 190 mm, 65°
	FC175R 190 mm, 65°	FC185R 190 mm, 65°	FC195R 190 mm, 65°	FC206R 190 mm, 90°	FC216R 190 mm, 90°
	FC177R 280 mm, 25°	FC187R 280 mm, 25°	FC196R 190 mm, 90°	FC207R 280 mm, 25°	FC217R 280 mm, 25°
	FC178R 280 mm, 65°	FC188R 280 mm, 65°	FC197R 280 mm, 25°	FC208R 280 mm, 65°	FC218R 280 mm, 65°
	FC179R 280 mm, 90°		FC198R 280 mm, 65°	FC209R 280 mm, 90°	FC219R 280 mm, 90°
			FC199R 280 mm, 90°		
Laparoscopic Clip Appliers / Laparoskopische Clip Anlege- zangen	PL801R 310 mm, Shaft diam. / Ø 5 mm	PL802R 310 mm, Shaft diam. / Ø 5 mm	PL806R 310 mm, Shaft diam. / Ø 10 mm	PL807R 310 mm, Shaft diam. / Ø 10 mm	PL808R 310 mm, Shaft diam. / Ø 12 mm
		PL822R 420 mm, Shaft diam. / Ø 5 mm	PL826R 420 mm, Shaft diam. / Ø 10 mm	PL827R 420 mm, Shaft diam. / Ø 10 mm	PL828R 420 mm, Shaft diam. / Ø 12 mm
Laparoscopic Clip Removal Forceps / Laparoskopische Clip Entfer- nungszangen			PL816R 310 mm, Shaft diam. / Ø 10 mm	PL817R 310 mm, Shaft diam. / Ø 10 mm	PL818R 310 mm, Shaft diam. / Ø 12 mm

SINGLE FIRE TITANIUM LIGATION-CLIPS

SINGLE FIRE TITAN LIGATUR-CLIPS



Titanium Ligation-Clips

- Material: titanium
- A diamond-shaped inner clip profile provides an enlarged contact surface.
- The special closing characteristic of the clip allows a repositioning of the clip and reduces the risk of tissue slippage out of the clip.
- Special soft load clip cartridge for easy clip release.
- Indentations on the cartridge sides for a more reliable handling.
- Adhesive surface at the cartridge back for precise fixation.

Titan Ligatur-Clips





- Material: Reintitan
- Die rautenförmige Innenprofilierung des Clips bietet eine vergrößerte Kontaktfläche.
- Spezielles Schließverhalten des Clips ermöglicht ein Repositionieren des Clips und reduziert das Risiko, dass Gewebe aus dem Clip gleitet.
- Spezielle Soft-Load-Clipmagazine für einfache Clipentnahme.
- Klebefläche auf der Rückseite der Magazine zur präzisen Fixierung.

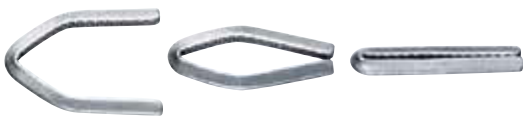

- Diamond-shaped inner clip profile.
- Rautenförmige Innenprofilierung des Clips.



- Closing behavior of the clip.
- Schließverhalten des Clips.

				Width x length Breite x Länge	Clips p. magazine Clips p. Magazin	No. of mag. p. pack Anz. Mag. p. Pack
PL565T	Small			4.2 x 3.0 mm	6	30
PL566T	Small Cardiopack			4.2 x 3.0 mm	24	8
PL567T	Medium			6.2 x 4.9 mm	6	30
PL568T	Medium-Large			8.8 x 7.8 mm	6	20
PL561T	Large			11.3 x 10.8 mm	6	20

SINGLE FIRE TITANIUM LIGATION-CLIPS

SINGLE FIRE TITAN LIGATUR-CLIPS



Clip Appliers

- Narrow, delicate instrument tips enable an improved overview.
- Product variety – versatile application due to wide product portfolio:
 - 150 mm, 203 mm and 280 mm instrument lengths
 - 25°, 65° and 90° jaw angulation
- Color coding simplifies the identification of suitable clip applicators and cartridges.

Clip Anlegezangen

- Schmale und feine Instrumentenspitzen bieten eine bessere Übersicht.
- Produktvielfalt – vielfältige Anwendungsmöglichkeiten durch breite Produktpalette:
 - Instrumentenlängen 150 mm, 203 mm und 280 mm
 - Maulabwinkelungen 25°, 65° and 90°
- Farbcodierung vereinfacht die Identifikation der passenden Clipgröße und Clip Anlegezange.

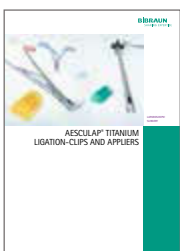

For further information
see our brochure C46811.

Weitere Informationen
finden Sie in unserem
Prospekt C46811.

At a glance Übersicht

	small	medium	medium-large	large
Titanium Ligation-Clips Titan Ligatur-Clips	PL565T	PL567T	PL568T	PL561T
	PL566T Cardiopack			
Clip appliers for open surgery Clip Anlegezangen für die offene Chirurgie	FB222R 150 mm, 25°	FB234R 150 mm, 25°	FB240R 203 mm, 25°	FB246R 203 mm, 25°
	FB223R 203 mm, 25°	FB235R 203 mm, 25°	FB243R 203 mm, 65°	FB249R 203 mm, 65°
	FB226R 203 mm, 65°	FB238R 203 mm, 65°	FB254R 203 mm, 90°	FB252R 203 mm, 90°
	FB224R 280 mm, 25°	FB236R 280 mm, 25°	FB242R 280 mm, 25°	FB248R 280 mm, 25°
	FB227R 280 mm, 65°	FB239R 280 mm, 65°	FB245R 280 mm, 65°	FB251R 280 mm, 65°
	FB225R 280 mm, 90°		FB255R 280 mm, 90°	FB253R 280 mm, 90°
Clip removal forceps for open surgery Clip Entfernungszange für die offene Chirurgie	FB282R			
Laparoscopic Clip Appliers Laparoskopische Clip Anlegezangen		PL504R 330 mm Shaft diam./Ø 10 mm	PL503R 330 mm Shaft diam./Ø 10 mm	PL528R 330 mm Shaft diam./Ø 12 mm

Challenger® Ti-P PNEUMATIC MULTI-FIRE CLIP APPLIER

Challenger® Ti-P PNEUMATISCHER MULTI-FIRE CLIP-APPLIKATOR



Challenger® Ti-P Ligation-Clips

- Material: titanium
- A diamond-shaped inner clip profile provides an enlarged contact surface.
- The special closing characteristic of the clip allows a repositioning of the clip and reduces the risk of tissue slippage out of the clip.

Challenger® Ti-P Clip Appliers

- Innovative technology - pneumatic clip loading.
- Modular design simplifies disassembly, cleaning, maintenance and sterile preparation.
- Reliable vessel occlusion.

Challenger® Ti-P Ligatur-Clips

- Material: Reintitan
- Die rautenförmige Innenprofilierung des Clips bietet eine vergrößerte Kontaktfläche.
- Spezielles Schließverhalten des Clips ermöglicht ein Repositionieren des Clips und reduziert das Risiko, dass Gewebe aus dem Clip gleitet.

Challenger® Ti-P Clip-Applikatoren

- Innovative Technologie - pneumatisches Clip-Nachladen.
- Modulare Bauweise erleichtert die Zerlegung, Aufbereitung, Pflege und Sterilbereitstellung.
- Zuverlässiger Gefäß-Verschluss.

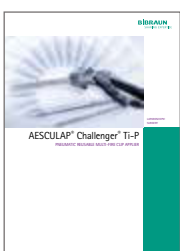

For further information
see our brochure C62311.

Weitere Informationen
finden Sie in unserem
Prospekt C62311.

Challenger® Ti-P Ligation-Clips Challenger® Ti-P Ligatur-Clips		Width x length Breite x Länge	Clip box	Clip-Box
PL574T	Small-Medium (SM)	3.6 x 4.35 mm	with 12 sterile cartridges, of 12 titanium clips and 12 CO ₂ cylinders, last clip color-coded	mit 12 sterilen Magazinen, à 12 Titanclips und 12 CO ₂ Patronen, letzter Clip farbkodiert
				
PL579T	Medium-Large (ML)	7.25 x 8.25 mm	with 12 sterile cartridges, of 8 titanium clips and 12 CO ₂ cylinders, last clip color-coded	mit 12 sterilen Magazinen, à 8 Titanclips und 12 CO ₂ Patronen, letzter Clip farbkodiert
				
Challenger® Ti-P Clip Appliers Challenger® Ti-P Clip-Applikatoren			Diam. Ø	Length Länge
PL604R	Small-Medium (SM)		5 mm	310 mm
PL603R	Small-Medium (SM)		5 mm	205 mm
				
PL606R	Medium-Large (ML)		10 mm	370 mm
PL608R	Medium-Large (ML)		10 mm	260 mm
				

Challenger® Ti MULTI-FIRE CLIP APPLIER

Challenger® Ti MULTI-FIRE CLIP-APPLIKATOR



Challenger® Ti Ligation-Clips

- Material: titanium
- A diamond-shaped inner clip profile provides an enlarged contact surface.
- The special closing characteristic of the clip allows a repositioning of the clip and reduces the risk of tissue slippage out of the clip.

Challenger® Ti Clip Appliers

- Modular design simplifies disassembly, cleaning, maintenance and sterile preparation.
- Separate functional elements for clip loading and clip closure.

Challenger® Ti Ligatur-Clips

- Material: Reintitan
- Die rautenförmige Innenprofilierung des Clips bietet eine vergrößerte Kontaktfläche.
- Spezielles Schließverhalten des Clips ermöglicht ein Repositionieren des Clips und reduziert das Risiko, dass Gewebe aus dem Clip gleitet.

Challenger® Ti Clip-Applikatoren

- Modulare Bauweise erleichtert die Zerlegung, Aufbereitung, Pflege und Sterilbereitstellung.
- Separate Funktionselemente für Clip-Transport und Clip-Verschluss.

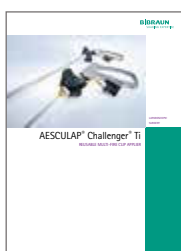

For further information
see our brochure C46111.

Weitere Informationen
finden Sie in unserem
Prospekt C46111.

Challenger® Ti Ligation-Clips Challenger® Ti Ligatur-Clips		Width x length Breite x Länge	Clip box	Clip-Box
PL572T	Small-Medium (SM)	 3.6 x 4.35 mm	with 12 sterile cartridges, of 12 titanium clips, last clip color-coded	mit 12 sterilen Magazinen, à 12 Titanclips, letzter Clip farbkodiert
				
PL569T	Medium-Large (ML)	 7.25 x 8.25 mm	with 12 sterile cartridges, of 8 titanium clips, last clip color-coded	mit 12 sterilen Magazinen, à 8 Titanclips, letzter Clip farbkodiert
				
Challenger® Ti Clip Applicators Challenger® Ti Clip-Applikatoren			Diam. Ø	Length Länge
PL512R	Small-Medium (SM)		5 mm	310 mm
PL600R	Small-Medium (SM)		5 mm	205 mm
PL506R	Medium-Large (ML)		10 mm	370 mm
PL508R	Medium-Large (ML)		10 mm	260 mm

HERLOON: HER...NIA BAL...LOON



Single use Her...loon balloon shaft

- Transparent shaft with a balloon at its distal end.
- Dilatation of balloon is performed to dissect the peritoneum from the abdominal wall and thus creation of the extraperitoneal space.
- Dilated transparent balloon allows clear view of body structures.
- Elastic balloon material, allowing easy dilatation and adaptation to body tissue.
- Biocompatible material: PET shaft and silicone balloon.
- Gamma-sterilized, individual sterile packaging in Tyvek blister packs.

Reusable Her...loon trocar body including a blunt trocar pin

- Easy adaptation of the balloon shaft to the trocar body by engaging and securing with a retention ring.
- Cost-effective system due to the combination of single use balloon shaft and reusable trocar system.

Einmal-Ballonschaft Her...loon

- Transparenter Schaft mit einem Ballon am distalen Ende.
- Durch Dilatation des Ballons erfolgt die Trennung von Peritoneum und Bauchwand zur Schaffung eines extraperitonealen Raumes.
- Klare Sicht auf die Körperstrukturen durch die Transparenz des auf-dilatierten Ballons.
- Elastisches Ballonmaterial, das eine einfache Dilatation und Anpassung an das Körpergewebe gewährleistet.
- Körperverträgliches Material: Schaft aus PET und Ballon aus Silikon.
- Gammasterilisiert, einzeln steril verpackt in Tyvek-Blister-Verpackung.

Wiederverwendbarer Trokarkörper Her...loon mit stumpfem Trokardorn

- Einfache Adaption des Ballonschaftes an den Trokarkörper durch Einrasten und Sicherung über den Haltering.
- Wirtschaftliches System durch die Kombination von Einmal-Ballonschaft und wieder verwendbarem Trokarsystem.



For further information see our brochure C73002.

Weitere Informationen finden Sie in unserem Prospekt C73001.

Product Portfolio - Hernia Repair:
For further information see our brochures:

B16302 - Optilene Mesh LP
B47602 - Optilene Mesh
B15802 - Optilene Mesh Elastic
or www.optilene.com

Produktübersicht Hernienchirurgie:

Weitere Informationen finden Sie in unseren Prospekten:

B16301 - Optilene Mesh LP
B47601 - Optilene Mesh
B15801 - Optilene Mesh Elastic
oder www.optilene.de

			Diam. Ø	Length Länge
--	--	--	------------	-----------------

Her...loon



EJ871R	Trocar body for Her...loon consisting of: EJ872R: trocar body only EJ873R: blunt trocar pin (length: 300 mm)	Trokarkörper für Her...loon bestehend aus: EJ872R Trokarkörper allein EJ873R Stumpfer Trokardorn (Länge: 300 mm)	10 mm	300 mm
--------	--	--	-------	--------

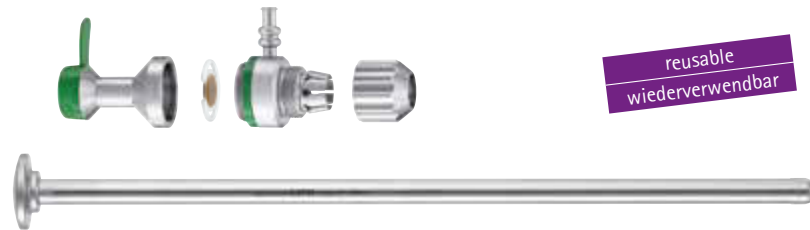

EJ870P	Her...loon single use Balloon shaft Consisting of: shaft with distal balloon and hand pump. Individual sterile packaging in Tyvek blister. Pack of 10 pcs.	Her...loon Einmal-Ballonschaft Bestehend aus: Schaft mit distalem Ballon und Handpumpe, einzeln steril verpackt in Tyvek-Blister Pack à 10 Stück.	10 mm	
--------	---	--	-------	--



SK271C	Stopcock for trocar body	Verriegelungshahn für den Trokarkörper		
--------	--------------------------	--	--	--



EJ571P	Silicone flap valve Pack of 20 pcs.	Silikon-Klappenventil Pack à 20 Stück	10-12.5 mm	
--------	--	--	------------	--



SUCTION / IRRIGATION TUBINGS FOR GRAVITY FEED SYSTEM

SAUG- / SPÜLSCHLÄUCHE FÜR DIREKTEN ANSCHLUSS AN SPÜLBEUTEL



Suction / Irrigation Device

- Color-coded suction / irrigation buttons
- Transparent suction / irrigation trumpet valve
- Ergonomically designed handle
- Distal holes
- Multi connection suction adapters

Saug-Spülsystem

- Farbcodierte Saug- / Spülknöpfe
- Transparenter Saug- / Spülhandgriff mit Trompetenventil
- Ergonomisches Handstück
- Distale Bohrungen
- Multi-Adapter Sauganschluss

DEHP
FREE/FREI

	Length Länge	Pcs. per pack Stk. pro Pack
--	-----------------	--------------------------------

Laparoscopic suction / irrigation tubing with suction / irrigation handle and 5 mm cannula
Laparoskopischer Saug- / Spülschlauch mit Saug- / Spülhandgriff und 5 mm Rohr

PG036SU

3000 mm

10

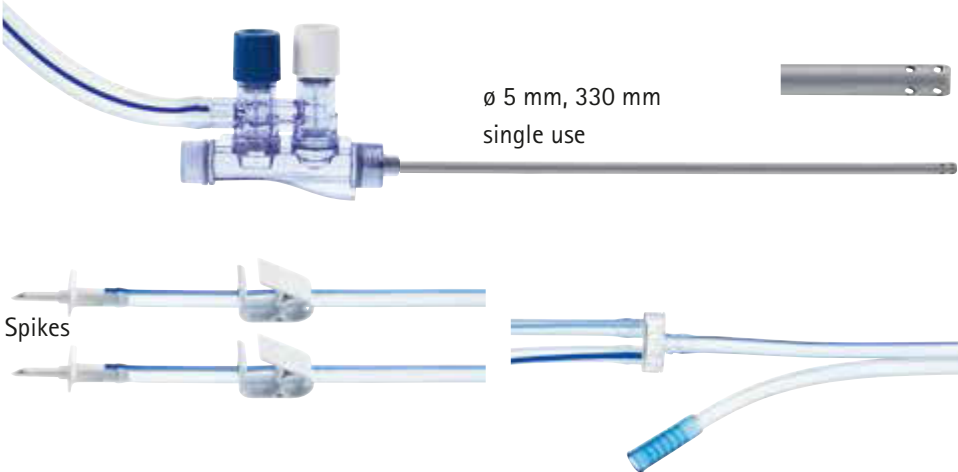

Laparoscopic suction-irrigation tubing with suction / irrigation handle
Laparoskopischer Saug- / Spülschlauch mit Saug- / Spülhandgriff

PG037SU

3000 mm

10

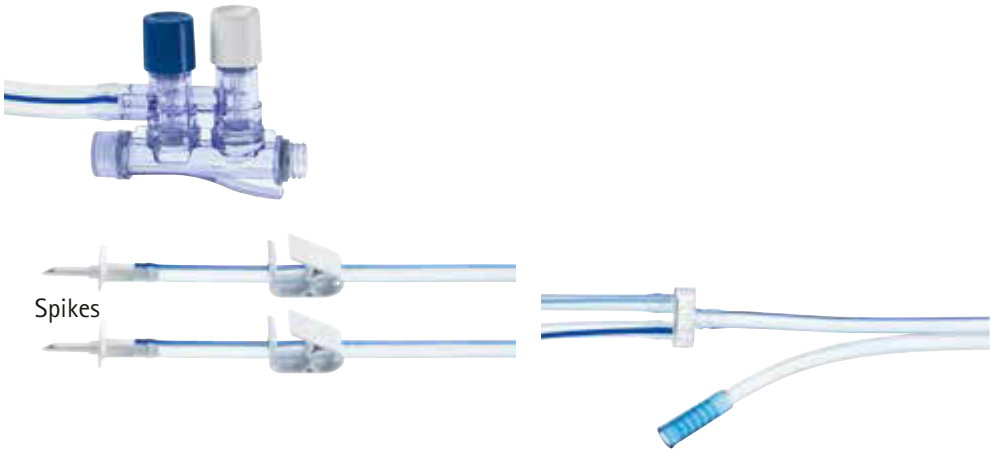

SUCTION / IRRIGATION TUBINGS FOR LAP PUMP 'FLUID 3'

SAUG- / SPÜLSCHLÄUCHE FÜR LAP PUMPE 'FLUID 3'



Tubing sets

- With integrated pressure membrane
- Pack containing 10 pieces

Schlauchsets

- Mit integrierter Druckmembran
- Packung à 10 Stück

			Length Länge	Pcs. per pack Stk. pro Pack
--	--	--	-----------------	--------------------------------

Universal irrigation tubing
Universeller Spülschlauch

PG072SU	<ul style="list-style-type: none"> With pressure membrane Suitable for PG055, PG070 	<ul style="list-style-type: none"> Mit Druckmembran Für PG055, PG070 geeignet 	4500 mm	10
---------	---	---	---------	----



PG073SU			4500 mm	10
---------	--	--	---------	----



Laparoscopic suction / irrigation tubing with suction irrigation handle
Laparoskopischer Saug- / Spülschlauch mit Saug- / Spülhandgriff

PG074SU	<ul style="list-style-type: none"> Suitable for lap pump PG070 With integrated pressure membrane With suction / irrigation trumpet valve handle without cannula With multi adapter suction connector Color-coded suction / irrigation buttons Transparent valve For compatible suction-irrigation cannulas refer to page 51 	<ul style="list-style-type: none"> Für Lap-Pumpe PG070 geeignet Mit integrierter Druckmembran Mit Saug-/Spülhandgriff (Trompetenventil), ohne Saug-/Spülrohr Mit Multi-Adapter Sauganschluss Farblich codierte Saug-/Spültaster Durchsichtiger Saug-/Spülhandgriff Geeignete Saug-Spülrohre finden Sie auf Seite 51 	4500 mm	10
---------	--	--	---------	----

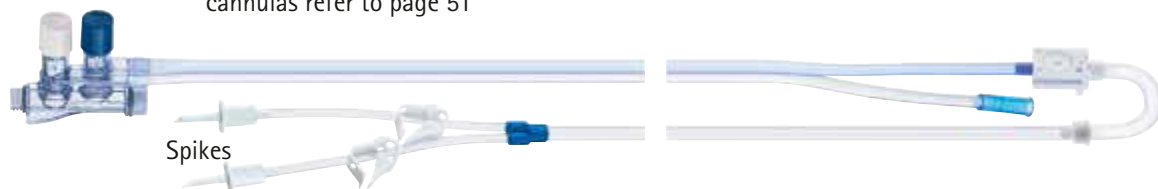

PG075SU

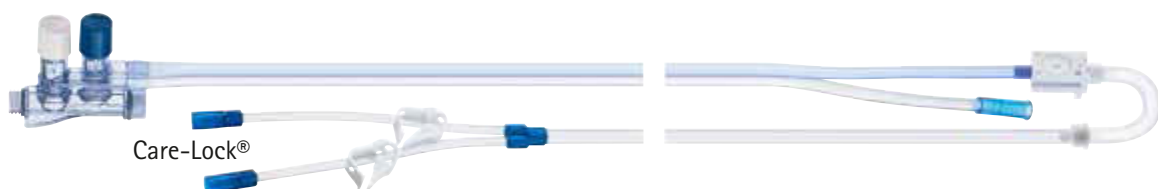

SUCTION / IRRIGATION TUBINGS FOR MULTIFLOW PUMP SAUG- / SPÜLSCHLÄUCHE FÜR MULTIFLOW PUMPE



Tubing sets

- With integrated transponder technology
- With integrated pressure membrane
- Easy to apply tubing into pump

Schlauchsets

- Mit integrierter Transponder-Technologie
- Mit integrierter Druckmembran
- Einfaches Einlegen des Schlauches in die Schlauchvorrichtung am Pumpenkopf



For further information see our brochure C62911.

Weitere Informationen finden Sie in unserem Prospekt C62911.

			Length Länge	Pcs. per pack Stk. pro Pack
--	--	--	-----------------	--------------------------------

Laparoscopic suction / irrigation tubing with suction / irrigation handle
Laparoskopischer Saug- / Spülschlauch mit Saug- / Spülhandgriff

PG122SU	<ul style="list-style-type: none"> ■ Suitable for PG130, PG145 ■ With suction / irrigation trumpet valve handle without cannula ■ With pressure membrane ■ With multi-adapter suction connector ■ Color-coded buttons ■ Transparent valve ■ For compatible suction-irrigation cannulas refer to page 51 	<ul style="list-style-type: none"> ■ Für PG130, PG145 geeignet ■ Mit Saug- / Spülhandgriff (Trompetenventil), ohne Saug- / Spülrohr ■ Mit Druckmembran ■ Mit Multi-Adapter Sauganschluss ■ Farblich codierte Saug- / Spültaster ■ Durchsichtiger Saug- / Spülhandgriff ■ Geeignete Saug- / Spülrohre finden Sie auf Seite 51 	4500 mm	10
---------	--	---	---------	----



PG123SU



Universal irrigation tubing with transponders
Universeller Spülschlauch mit Transponder

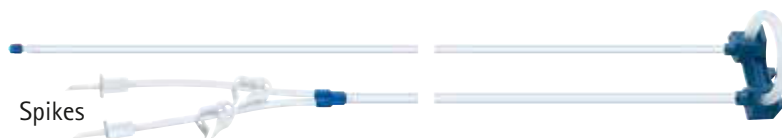

PG132SU	<ul style="list-style-type: none"> ■ Suitable for PG130, PG145 ■ With Luer-Lock connectors ■ With pressure membrane 	<ul style="list-style-type: none"> ■ Für PG130, PG145 geeignet ■ Mit Luer-Lock Anschluss ■ Mit Druckmembran 	4500 mm	10
---------	--	--	---------	----



PG133SU

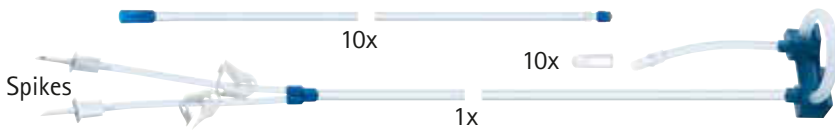
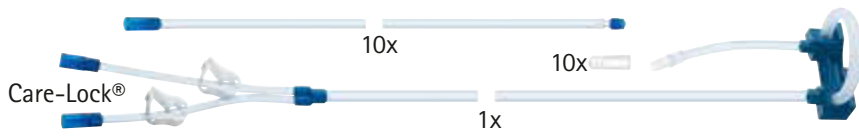

SUCTION / IRRIGATION TUBINGS FOR MULTIFLOW PUMP SAUG- / SPÜLSCHLÄUCHE FÜR MULTIFLOW PUMPE

			Length Länge	Pcs. per pack Stk. pro Pack
Irrigation day tubing set with transponder Tagesschlauchset mit Transponder				
PG134SU	<ul style="list-style-type: none"> Suitable for PG130, PG145 With pressure membrane Consisting of 1 day tubing, 10 single use patient tubings and 10 sterile caps for day tubing 	<ul style="list-style-type: none"> Für PG130, PG145 geeignet Mit Druckmembran Bestehend aus 1 Tagesschlauch, 10 Einmal Patientschläuchen und 10 Sterilkappen für Tagesschlauch 	4500 mm	10 + 1
				
PG135SU			4500 mm	10 + 1
				
Irrigation day tubing with transponder Tagesschlauch mit Transponder				
PG136	<ul style="list-style-type: none"> Suitable for PG130, PG145 Suitable for up to 10 uses within 24 hours Can be connected with single use patient tubings 	<ul style="list-style-type: none"> Für PG130, PG145 geeignet Kann bis zu 10-mal innerhalb 24 Stunden verwendet werden Wird mit Einmal-Patientenschläuchen verbunden 	1650 mm	10
				
PG137			1650 mm	10
				

			Length Länge	Pcs. per pack Stk. pro Pack
--	--	--	-----------------	--------------------------------

Y-tubing
Y-Schlauch

PG138SU	<ul style="list-style-type: none"> ■ Suitable for PG145 ■ For arthroscopy use (in combination with motor hand piece) ■ For hys / uro use (in combination with resectoscopes) ■ With multi-adapter suction connector 	<ul style="list-style-type: none"> ■ Für PG145 geeignet ■ Für Arthroskopie-Anwendungen (in Kombination mit Motoren-handstück) ■ Für Hys- / Uro-Anwendungen (in Verbindung mit Resektoskopen) ■ Mit Multi-Adapter Sauganschluss 	3000 mm	10
---------	---	--	---------	----



Vacuum suction tube with hydrophobic filter
Vakuum Saugschlauch mit hydrophobem Filter

PG139	<ul style="list-style-type: none"> ■ Suitable for PG145 ■ With hydrophobic filter ■ With multi-adapter suction connector 	<ul style="list-style-type: none"> ■ Für PG145 geeignet ■ Mit hydrophobem Filter ■ Mit Multi-Adapter Sauganschluss 	2000 mm	10
-------	---	---	---------	----



reusable
wiederverwendbar









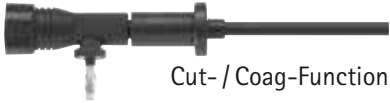

SUCTION / IRRIGATION CANNULAS

SAUG- / SPÜLROHRE



- Screw-on-connection between handle and suction / irrigation cannula.
- Reusable and single use cannulas.
- Monopolar single use electrodes with exposed HF tip in retracted shaft position.
- Compatible with
 - Gravity Feed Systems
 - Lap pump 'Fluid 3'
 - MultiFlow Pump
- Monopolar single use electrodes with 4 mm HF pin connector.

- Schraubverbindung zwischen Handgriff und Saug- / Spülrohr.
- Wiederverwendbare und Einmalrohre.
- Monopolare einmal verwendbare Saug- / Spülelektroden mit freiliegender HF-Instrumentenspitze bei zurückgezogener Schaftposition.
- Geeignet für
 - den direkten Anschluss an Spülbeutel
 - Lap Pumpe 'Fluid 3'
 - MultiFlow Pumpe
- Die monopolaren einmal verwendbaren Saug- / Spülelektroden weisen einen 4 mm HF-Pin auf.



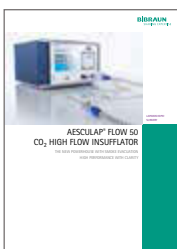

			Diam. Ø	Length Länge	Pcs. per pack Stk. pro Pack
Monopolar single use suction-irrigation cannulas Monopolare Einmal-Saug- / Spülrohre					
PG032SU (L type)		Cut- / Coag-Function Schneide- / Coag-Funktion	5 mm	340 mm	10
		Suction- / Irrigation-Function Saug- / Spül-Funktion			
PG033SU (Spatula type)		Coag-Function Coag-Funktion	5 mm	340 mm	10
		Suction-Irrigation-Function Saug- / Spül-Funktion			
PG035SU (Coag type)			5 mm	340 mm	10
Single use suction-irrigation cannulas Einmal-Saug- / Spülrohre					
PG042SU			5 mm	330 mm	10
PG043SU			5 mm	450 mm	10
Suction-irrigation cannulas Saug- / Spülrohre					
PG041R		reusable wiederverwendbar	3.5 mm	310 mm	1
PG038R			5 mm	330 mm	1
PG039R			10 mm	330 mm	1

INSUFFLATION SYSTEMS INSUFFLATIONSSYSTEME

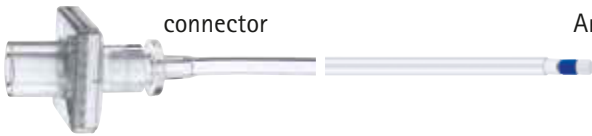
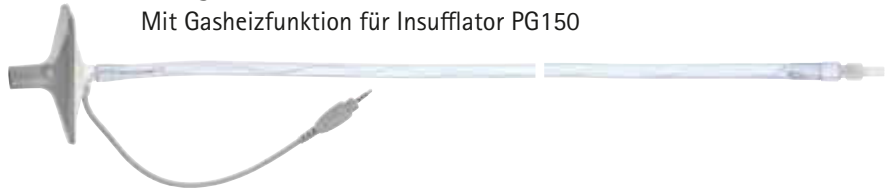

For further information see our
brochure C94202.

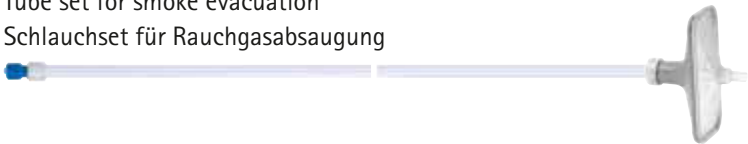
Weitere Informationen finden
Sie in unserem Prospekt C94201.

		Diam. Ø	Length Länge	Pcs. per pack Stk. pro Pack
Insufflation tube with hydrophobic CO₂ filter Insufflationsschlauch mit hydrophobem CO ₂ -Filter				
PG012	For insufflators / für Insufflatoren: PG060, PG080, PG081, PG120, PG150 <ul style="list-style-type: none"> ■ Incl. CO₂ filter ■ With connector ISO Standard 15/22-15 mm and Luer-Lock connector 	9 mm	3000 mm	10
	<ul style="list-style-type: none"> ■ Mit CO₂ Filter ■ Mit Konnektor ISO-Standard 15/22-15 mm und Luer-Lock Anschluss 			
				
PG096SU	With gas heat function for insufflator PG150 Mit Gasheizfunktion für Insufflator PG150		3000 mm	10
				
Hydrophobic CO₂ filter / Hydrophober CO₂-Filter				
PG019	For insufflators / für Insufflatoren: PG060, PG080, PG081, PG120, PG150 <ul style="list-style-type: none"> ■ With connector ISO Standard (15/22-15 mm connector) 			25
	<ul style="list-style-type: none"> ■ Mit Konnektor ISO-Standard (15/22-15 mm Anschluss) 			
				
Accessories for smoke evacuation for Aesculap insufflator PG150 Rauchabsaugungszubehör für Aesculap Insufflator PG150				
PG106	Smoke evacuation filter cassette Filterkassette für Rauchgasabsaugung			30
				
				reusable wiederverwendbar
PG107SU	Tube set for smoke evacuation Schlauchset für Rauchgasabsaugung		3000 mm	10
				
Veress insufflation needle / Veress Insufflationsnadel				
EJ995		2.1 mm	120 mm	20
EJ996		2.1 mm	150 mm	20

RETRIEVAL BAG BERGEBEUTEL



Retrieval bag

- Four different models
- Stable, transparent bag
- For use with 10 mm trocars
- Insertion sleeve for easy insertion









Bergebeutel

- Vier unterschiedliche Modelle
- Stabiler, transparenter Beutel
- Zur Verwendung mit 10 mm Trokaren
- Einführhülse zum leichten Einbringen

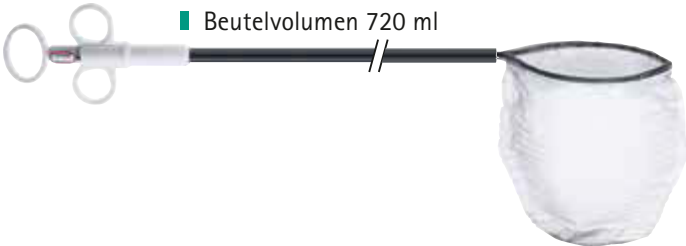

For further information see our brochure C23211.

Weitere Informationen finden Sie in unserem Prospekt C23211.

			Width x length Breite x Länge	Pcs. per pack Stk. pro Pack	
Retrieval bag Bergebeutel					
EJ025SU	<p>SIMPLE</p> <ul style="list-style-type: none"> Low-cost retrieval bag Red cord for secure bag holding Bag volume 200 ml 	 <ul style="list-style-type: none"> Preiswerter Bergebeutel Rotes Band zum sicheren Greifen des Beutels Beutelvolumen 200 ml 		76 x 150 mm	20
Retrieval bag with memory wire Bergebeutel mit Memorydraht					
EJ022SU	<ul style="list-style-type: none"> Suitable for intra-abdominal opening and insertion of tissue Suitable for intra-abdominal closure Tapered bag design for removal Bag volume 210 ml 	 <ul style="list-style-type: none"> Geeignet intraabdominelles Öffnen und Einbringen des Resektats Geeignet zum intra-abdominellen Verschluss Konische Beutelform zum Entfernen Beutelvolumen 210 ml 		85 x 160 mm	10
Detachable retrieval bag Abwerfbarer Bergebeutel					
	<ul style="list-style-type: none"> Self-opening with metal ring Bag can be opened and closed intraoperatively Bag can be intraoperatively detached 	<ul style="list-style-type: none"> Selbstöffnend durch Drahtsperre Intraoperatives Öffnen und Schließen des Beutels möglich Beutel kann intraabdominell abgelöst werden 			
EJ023SU	<ul style="list-style-type: none"> Bag volume 260 ml 	 <ul style="list-style-type: none"> Beutelvolumen 260 ml 		90 x 150 mm	5
EJ024SU	<ul style="list-style-type: none"> Bag volume 720 ml 	 <ul style="list-style-type: none"> Beutelvolumen 720 ml 		130 x 170 mm	5

3D VISUAL SYSTEM

3D VISUELLES SYSTEM



Sterile camera drape for EinsteinVision® 2.0

- Sterile cover: sterile barrier between patient and camera
- Process optimization (product remains in the OR)
- Fewer interfaces (saves time and reduces sources of error)
- Consistent image quality (no thermal sterile preparation)
- Simple handling
- Reduces the risk of cross-contamination

Steriler Kameraüberzug für EinsteinVision® 2.0

- Sterilüberzug: sterile Barriere zwischen Patient und Kamera
- Prozessoptimierung (Produkt verbleibt im OP)
- Weniger Schnittstellen (spart Zeit und reduziert Fehlerquellen)
- Gleichbleibende Bildqualität (Keine thermische Sterilaufbereitung)
- Einfache Handhabung
- Reduziert das Risiko von Kreuzkontaminationen

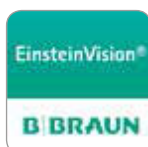

For further information
see our brochure
C92611 or iPad App.

Weitere Informationen
finden Sie in unserem
Prospekt C92611 oder
in unserer iPad App.

	Diam. Ø	Pcs. per pack Stk. pro Pack
--	------------	--------------------------------

EinsteinVision® 2.0 Sterile drape for 0° camera system
 EinsteinVision® 2.0 Sterilüberzieher für Kamerakopf, 0°

EV2-000055

10 mm

16



EinsteinVision® 2.0 Sterile drape for 30° camera system
 EinsteinVision® 2.0 Sterilüberzieher für Kamerakopf, 30°

EV2-000056

10 mm

16



3D VISUAL SYSTEM

3D VISUELLES SYSTEM



Sterile camera drape for EinsteinVision® 3.0

- Sterile cover: sterile barrier between patient and camera
- Process optimization (product remains in the OR)
- Fewer interfaces (saves time and reduces sources of error)
- Consistent image quality (no thermal sterile preparation)
- Simple handling
- Reduces the risk of cross-contamination

Steriler Kameraüberzug für EinsteinVision® 3.0

- Sterilüberzug: sterile Barriere zwischen Patient und Kamera
- Prozessoptimierung (Produkt verbleibt im OP)
- Weniger Schnittstellen (spart Zeit und reduziert Fehlerquellen)
- Gleichbleibende Bildqualität (Keine thermische Sterilaufbereitung)
- Einfache Handhabung
- Reduziert das Risiko von Kreuzkontaminationen

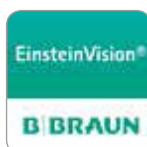

For further information
see our brochure
C94102 or iPad App.

Weitere Informationen
finden Sie in unserem
Prospekt C94101 oder
in unserer iPad App.

	Diam. Ø	Pcs. per pack Stk. pro Pack
--	------------	--------------------------------

EinsteinVision® 3.0 Sterile drape for 0° camera system
 EinsteinVision® 3.0 Sterilüberzieher für Kamerakopf, 0°

PV641SU



10 mm

10

EinsteinVision® 3.0 Sterile drape for 30° camera system
 EinsteinVision® 3.0 Sterilüberzieher für Kamerakopf, 30°

PV642SU



10 mm

10

2D VISUAL SYSTEM

2D VISUELLES SYSTEM



Sterile 2D camera drape

- Sterile covering of camera head and cable
- Suitable for all AESCULAP® 2D camera heads

Sterile anti fog solution for endoscopes

- Suitable for all AESCULAP® rigid rod lens endoscopes
- Set including 0.8 ml solution and sponge with adhesive surface on the back
- Non alcoholic solution
- Packing fits suture rack

Sterilüberzug für 2D Kamera

- Sterile Abdeckung von Kamerakopf mit Kabel
- Geeignet für alle AESCULAP® 2D Kameraköpfe

Antibeschlagmittel für Endoskope

- Geeignet für alle starren AESCULAP® Stablinseenendoskope
- Set beinhaltet 0,8 ml Lösung und Schwamm mit Kleberücken
- Lösung auf nicht alkoholischer Basis
- Verpackung geeignet für Nahtmaterial Regal

	Diam. Ø	Length Länge	Pcs. per pack Stk. pro Pack
--	------------	-----------------	--------------------------------

Standard sterile camera drape
Standard Sterilüberzug für Kamera

JG904



15 cm

250 cm

25

Anti fog solution for endoscopes
Antibeschlagmittel für Endoskope

JG910



10

HF-SURGERY HF-CHIRURGIE



Single use patient plates

- Highly adhesive
- Uniform adhesion over the entire plate surface
- Skin compatibility due to medical grade polyacrylate adhesive
- Compatible with any current surgical HF-units

Neutralelektroden

- Hohe Klebekraft
- Gleichmäßige und vollflächige Haftung
- Hautverträglichkeit durch medizinischen Polyacrylatkleber
- Kompatibel mit allen gängigen HF-Chirurgiegeräten



For further information see our brochure C30481.

Weitere Informationen finden Sie in unserem Prospekt C30481.

Single use patient plates
Einmalneutralelektroden

for children / für Kinder: Max. 200 W,  < 5-15 kg



72 cm² (*)

- GK083
- Non-split
 - 25 pieces individually packed
 - Ungeteilt
 - 25 Stück einzeln verpackt



71 cm² (*) (**)

- GK084
- Split
 - 25 pieces individually packed
 - Geteilt
 - 25 Stück einzeln verpackt

for adults / für Erwachsene



134 cm² (*)

- GK080
- Non-split
 - 25 pieces individually packed
 - Ungeteilt
 - 25 Stück einzeln verpackt

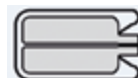

144 cm² (*) (**)

- GK081
- Split
 - 25 pieces individually packed
 - Geteilt
 - 25 Stück einzeln verpackt

- GK091
- Split
 - 50 pieces in peel packs of 5 each
 - Geteilt
 - 50 Stück im Peel Pack zu 5 Stück

- GK100
- Non-split
 - PE bag of 50
 - Ungeteilt
 - PE Beutel zu 50 Stück

- GK101
- Split
 - PE bag of 50 pieces
 - Geteilt
 - PE Beutel zu 50 Stück

Single use universal patient plate
Einmal-Universalneutralelektrode

for adults and children / für Erwachsene und Kinder



110 cm² (*) (**)

- GK107
- Split
 - 50 pieces in peel packs of 5 each
 - Geteilt
 - 50 Stück im Peel Pack zu 5 Stück

(* Conductive area / Leitfähige Fläche

(** Only for units with REM function / Nur für Geräte mit REM-Funktion

HF-SURGERY HF-CHIRURGIE



For further information see our brochure C30481.

Weitere Informationen finden Sie in unserem Prospekt C30481.

			Length Länge	Pcs. per pack Stk. pro Pack
--	--	--	-----------------	--------------------------------

Disposable electrode handle
Einmalhandgriff für Elektroden

GN211	Suitable for / Geeignet für: Aesculap, ACMI, Berchtold, Conmed, Martin, Valleylab			50
-------	--	--	--	----



- Single use knife electrode inclusive
- With 3 m attached cable with 3 pin connector
- Inklusive Einmalmesserelektrode
- 3 m fest angeschlossenes Kabel mit 3 Pin Stecker

Ball electrodes
Kugelelektroden

GK164R	■ Suitable for single use handle GN211	■ Passend zu Einmalhandgriff GN211	70 mm	50
--------	---	---------------------------------------	-------	----



Needle electrodes
Nadelelektroden

GK165R	■ Suitable for single use handle GN211	■ Passend zu Einmalhandgriff GN211	70 mm	50
--------	---	---------------------------------------	-------	----



HF-SURGERY

HF-CHIRURGIE



Arthroscopy HF-Electrodes

- With 4 mm pin diameter and hexagonal anti-twist protection
- Insulated up to the tips
- Pack containing 5 pieces, individually sterile packed

Arthroskopie HF-Elektroden

- Mit 4 mm Instrumentenaufnahme und 6-Kant Verdrehsicherung
- Isoliert bis zur Spitze
- Packung à 5 Stück, einzeln steril verpackt





For further information see our brochure C30481.

Weitere Informationen finden Sie in unserem Prospekt C30481.

		Length Länge	Pcs. per pack Stk. pro Pack
--	--	-----------------	--------------------------------

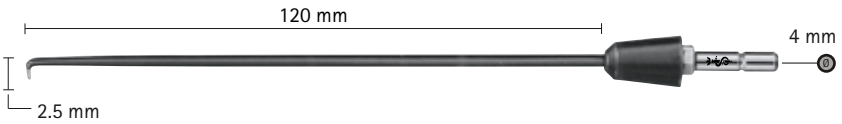
Hook electrodes
Hakenelektroden

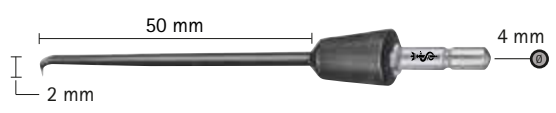
GK432R		120 mm	5
GK433R		120 mm	5
GK434R		120 mm	5
GK436R		50 mm	5

Ball electrode
Kugelelektrode

GK435R		120 mm	5
--------	--	--------	---

Reusable Electrode handle with two finger pushbuttons
Wiederverwendbarer Elektrodenhandgriff mit Doppelfingertastern

GN236			reusable wiederverwendbar
-------	--	--	--------------------------------------

SUSI® – SINGLE USE SURGICAL INSTRUMENTS

SUSI® – CHIRURGISCHE EINMALINSTRUMENTE



SUSI® - Single Use Surgical Instruments

Smart instruments anticipate user needs – like Aesculap's Single Use Surgical Instruments made from high-tech material. As precise as steel instruments, they are easier to handle regarding the entire process and clearly recognisable as single use instruments. This significantly simplifies the work of inpatient, outpatient and central sterile supply departments.

- Sterile, single packaged in dispenser box

SUSI® - Chirurgische Einmalinstrumente

Bewährte Instrumente für den stationären Alltag – so auch die chirurgischen AESCULAP® Einmalinstrumente aus Hightech-Material. Sie sind so präzise wie Stahlinstrumente, einfacher in der Handhabung des Gesamtprozesses und eindeutig als Einweginstrument erkennbar. Dies erleichtert die Arbeit von Station, Ambulanz und Zentralsterilisation deutlich.



- Steril, einzeln verpackt im Spenderkarton



For further patterns and information see our brochure C82002.

Weitere Modelle und Informationen finden Sie in unserem Prospekt C82001.

SUSI® – sample patterns / SUSI® – Produktauswahl

				Length Länge	Pcs. per pack Stück pro Packung
<p>SUSI® surgical scissors SUSI® Chirurgische Schere</p>					
BC324SU	<ul style="list-style-type: none"> ■ Sharp / blunt ■ Straight 	<ul style="list-style-type: none"> ■ Spitz-stumpf ■ Gerade 		145 mm	20
					
<p>SUSI® MAYO-HEGAR needle holder SUSI® MAYO-HEGAR Nadelhalter</p>					
BM235SU				150 mm	20
					
<p>SUSI® ADSON dissecting forceps SUSI® ADSON anatomische Pinzette</p>					
BD222SU	<ul style="list-style-type: none"> ■ Fine ■ Without teeth 	<ul style="list-style-type: none"> ■ Fein ■ Ohne Zähne 		120 mm	20
					

SUSI® – SINGLE USE SURGICAL INSTRUMENTS

SUSI® – CHIRURGISCHE EINMALINSTRUMENTE



Procedure sets

- Always complete
- Always sterile (sterilised in acc. to validated sterilisation process)
- Facilitates clear cost allocation
- No additional service cost (e.g. repair cost)
- Various sets available

Chirurgische Einmal-Sets

- Immer komplett verfügbar
- Immer steril (nach einem validierten Aufbereitungsverfahren)
- Klare Kostenzuordnung
- Immer ohne Nebenkosten (z. B. Reparatur)
- Verschiedene Sets zur Auswahl

SUSI® Procedure sets – two examples / SUSI® Chirurgische Einmal-Sets – zwei Beispiele

Pieces
Stück

Suture Set 1 Naht-Set 1

5061000



Defix kidney tray, white	Defix Nierenschale, weiß	1
Bowl, transparent, 120 ml	Schale, transparent, 120 ml	1
Gauze swabs, plumsize	Mulltupfer, pflaumengroß	5
SUSI® forceps Adson, sharp, 120 mm	SUSI® Pinzette Adson, scharf, 120 mm	1
SUSI® needle holder Mayo-Hegar, 150 mm	SUSI® Nadelhalter Mayo-Hegar, 150 mm	1
SUSI® scissors, sharp / blunt, 145 mm	SUSI® Chirurgische Schere, spitz / stumpf, 145 mm	1
SUSI® haemostatic forceps Pean, straight, 145 mm	SUSI® Arterienklemme Pean, gerade, 145 mm	1
Order unit: PAK = Pack of 20 sets	Bestelleinheit: PAK = Packung à 20 Sets	

Surgical Dressing Set 2 Wundversorgungs-Set 2

5061020



Defix kidney tray, white	Defix Nierenschale, weiß	1
Bowl, transparent, 120 ml	Schale, transparent, 120 ml	1
Drape, 75 x 90 cm	Abdecktuch, 75 x 90 cm	1
Hole towel, 75 x 75 cm, adhesive area	Lochtuch, 75 x 75 cm, Klebezone	1
Gauze compress, 7.5 x 7.5 cm, 12-fold (ply)	Mullkomresse, 7,5 x 7,5 cm, 12-fach	10
Gauze swabs, plumsize	Mulltupfer, pflaumengroß	5
SUSI® forceps Adson, sharp, 120 mm	SUSI® Pinzette Adson, scharf, 120 mm	1
SUSI® needle holder Mayo-Hegar, 150 mm	SUSI® Nadelhalter Mayo-Hegar, 150 mm	1
SUSI® scissors, sharp / blunt, 145 mm	SUSI® Chirurgische Schere, spitz / stumpf, 145 mm	1
SUSI® haemostatic forceps Pean, straight, 145 mm	SUSI® Arterienklemme Pean, gerade, 145 mm	1
Order unit: PAK = Pack of 20 sets	Bestelleinheit: PAK = Packung à 20 Sets	

AESCULAP® SAFETY SCALPELS

AESCULAP® SICHERHEITSSKALPELLE

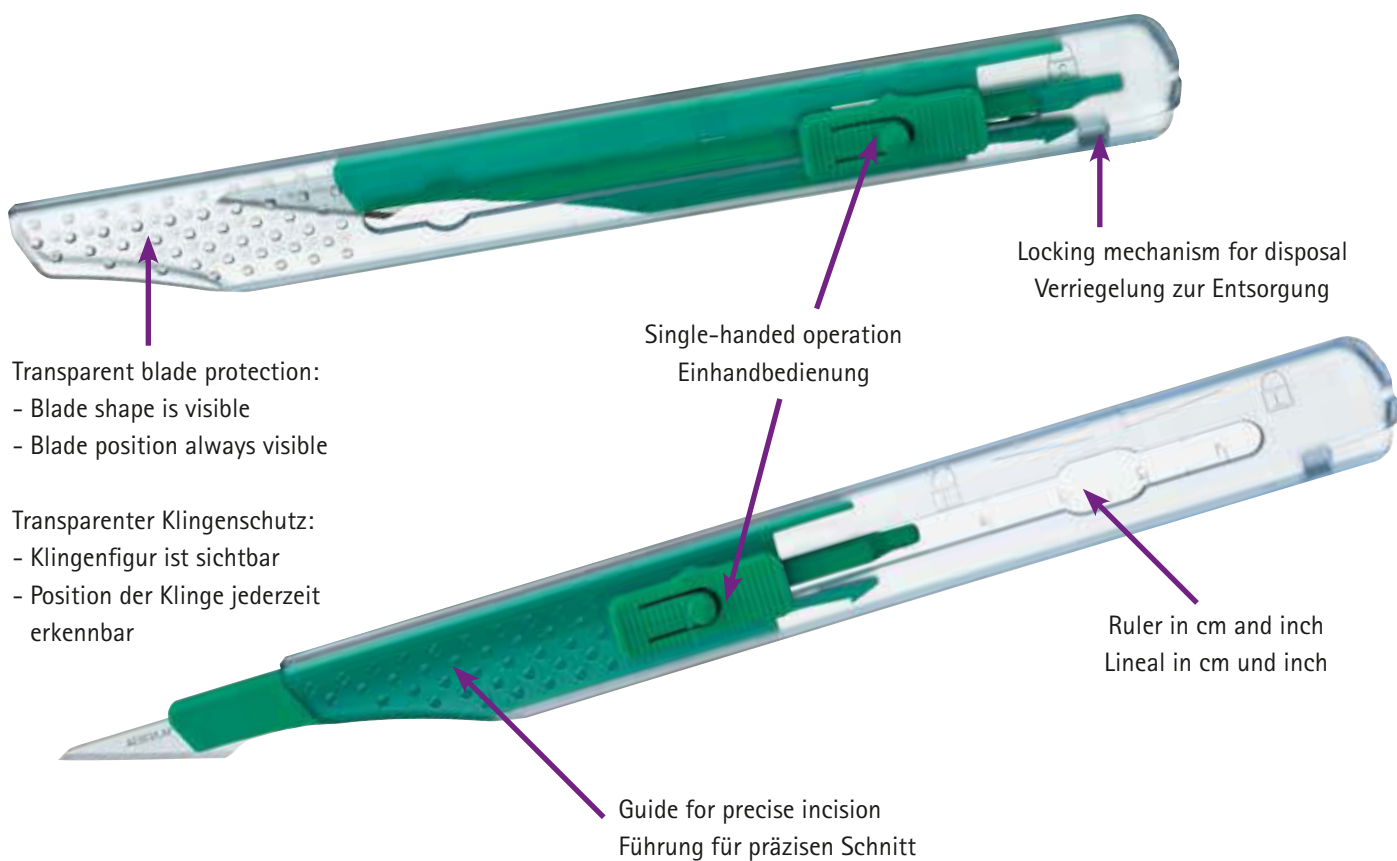

For further information see our brochure C65402.

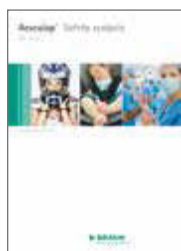

Weitere Informationen finden Sie in unserem Prospekt C27601.

Comparison between the new TRBA 250 requirements and features of the Aesculap safety scalpel
Erfüllen Sie die Anforderungen der TRBA 250 durch die Verwendung des Aesculap Sicherheitsskalpells

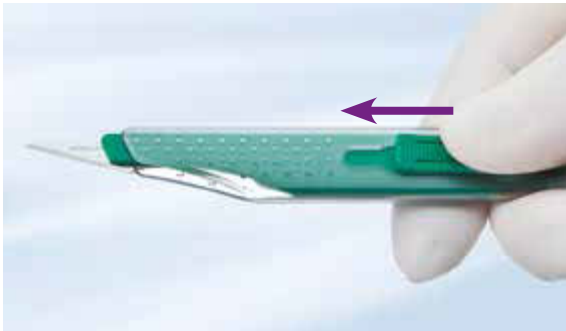

- § The safety mechanism is part of the system and compatible with other accessories.
- § Single-handed activation must be possible.
- ✓ The mechanism is activated automatically by sliding back the blade with one hand.

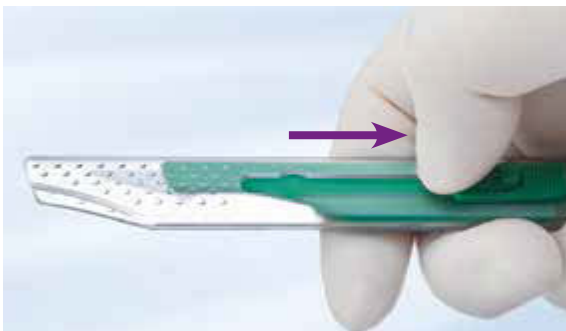

- § The safety mechanism prevents reuse.
- ✓ The blade is safely locked in the disposal position.
- § Using the safety product does not require a different technique of use.
- ✓ It is used in the same way as a standard single use scalpel.
- § The activation of the safety mechanism must be clearly indicated (palpable or audible).
- ✓ An audible „click“ indicates that the safety locking mechanism has been activated, and this can be seen and felt immediately.



"click"
"klick" palpable
fühlbar

- § Der Sicherheitsmechanismus ist Bestandteil des Systems und kompatibel mit anderem Zubehör.
- § Seine Aktivierung muss mit einer Hand erfolgen können.
- ✓ Der Mechanismus wird automatisch durch das Zurückschieben der Klinge mit einer Hand aktiviert.
- § Der Sicherheitsmechanismus schließt einen erneuten Gebrauch aus.
- ✓ Die Klinge wird in der Entsorgungsposition verriegelt.
- § Das Sicherheitsprodukt erfordert keine Änderung der Anwendungstechnik.
- ✓ Identische Handhabung bei der Operation im Vergleich zu Standard Einmalskalpellen.
- § Der Sicherheitsmechanismus muss durch ein deutliches Signal (fühlbar oder hörbar) gekennzeichnet sein.
- ✓ Die Aktivierung der Sicherheitsverriegelung ist mit einem „Klicken“ gekennzeichnet und sofort nach der Aktivierung sichtbar und fühlbar.

AESCULAP® SAFETY SCALPELS

AESCULAP® SICHERHEITSSKALPELLE



BA810SU
Fig. 10

BA811SU
Fig. 11

BA812SU
Fig. 12

BA813SU
Fig. 13

BA815SU
Fig. 15

BA815-1SU
Fig. 15-1

BA815-CSU
Fig. 15-C

BA818SU
Fig. 18

BA810SU-BA836SU

Sales unit PAK = Package of 10 pieces
Bestellereinheit PAK = Packung à 10 Stück



BA819SU
Fig. 19

BA820SU
Fig. 20

BA821SU
Fig. 21

BA822SU
Fig. 22

BA823SU
Fig. 23

BA824SU
Fig. 24

BA825SU
Fig. 25

BA836SU
Fig. 36

1/1

SURGICAL SINGLE USE INSTRUMENT CHIRURGISCHE EINMALINSTRUMENTE





















Surgical Blades

- Two types
 - Carbon steel
 - Stainless steel
- Pack containing 100 pieces

Skalpellklingen

- Zwei Ausführungen
 - Carbon Steel
 - Stainless Steel
- Packung à 100 Stück

Sterile blades carbon steel Sterile Klingen stainless steel		Sterile blades carbon steel Sterile Klingen stainless steel		Pcs. per pack Stk. pro Pack
Surgical blades for scalpel handles no. 3 Skalpellklingen für Handgriffe Nr. 3		Surgical blades for scalpel handles no. 4 Skalpellklingen für Handgriffe Nr. 4		
BB510 16600495		BB518 16600541		100 100
BB511 16600509		BB519 16615514		100 100
BB512 16600517		BB520 16600550		100 100
BB513 1665492		BB521 16600568		100 100
BB515 16600525		BB522 16600576		100 100
BB515-1		BB523 16600584		100
BB515-C		BB524 16600592		100
BB540 Double cutting / Doppelschneidig		BB525 16616634		100
BB542 Double cutting / Doppelschneidig		BB536 16615522		100
Stitch-cutter Fadenmesser				
BB500				100

STERILE SCALPELS

STERILSKALPELLE



Sterile scalpels

- Two types
 - Carbon steel
 - Stainless steel
- Transparent cover
- Pack containing 10 pieces













Sterilskalpelle

- Zwei Ausführungen
 - Carbon Steel
 - Stainless Steel
- Transparenter Klingenschutz
- Packung à 10 Stück



Sterile blades carbon steel Sterile Klengen stainless steel	Sterile blades carbon steel Sterile Klengen stainless steel	Length Länge	Pcs. per pack Stk. pro Pack
--	--	-----------------	--------------------------------

Sterile scalpels with plastic handle and blade protector
Sterilskalpelle mit Kunststoffheft und Klingenschutz

BA210 5518059		BA219		6" 150 mm	10 10
BA211 5518040		BA220 5518067		6" 150 mm	10 10
BA212 5518105		BA221 5518075		6" 150 mm	10 10
BA215 5518032		BA222 5518083		6" 150 mm	10 10
BA215-1		BA223 5518016		6" 150 mm	10 10
BA215-C		BA224 5518091		6" 150 mm	10 10
BA218				6" 150 mm	10 10
BA323SU		BA311SU		9" 230 mm	10 10

SURGICAL BLADES SKALPELLKLINGEN







Micro surgical blades

- Surgical blades packed sterile

Mikro Skalpellklingen

- Skalpellklingen steril verpakt

				Pcs. per pack Stk. pro Pack
Surgical blades Skalpellklingen				
BB361R		BB362R		10
BB365R		BB364R		10
BB367R		BB368R		10
BB363R				1
BB369R				1

			Diam. Ø	Length Länge
Reusable scalpel handle Wiederverwendbarer Skalpellhandgriff				
BB060R	Round / Rund		5 mm	450 mm, 17¾"
				

ENDOSCOPIC INSTRUMENTS AND ACCESSORIES

ENDOSKOPISCHE INSTRUMENTE UND ZUBEHÖR

Index

Art. No Art.-Nr.	Page Seite	Art. No Art.-Nr.	Page Seite	Art. No Art.-Nr.	Page Seite
1665492	79	BA215	81	BB361R	83
5061000	73	BA215-1	81	BB362R	83
5061020	73	BA215-C	81	BB363R	83
5518016	81	BA218	81	BB364R	83
5518032	81	BA219	81	BB365R	83
5518040	81	BA220	81	BB367R	83
5518059	81	BA221	81	BB368R	83
5518067	81	BA222	81	BB369R	83
5518075	81	BA223	81	BB500	79
5518083	81	BA224	81	BB510	79
5518091	81	BA311SU	81	BB511	79
5518105	81	BA323SU	81	BB512	79
16600495	79	BA810SU	76	BB513	79
16600509	79	BA811SU	76	BB515	79
16600517	79	BA812SU	76	BB515-1	79
16600525	79	BA813SU	76	BB515-C	79
16600541	79	BA815-1SU	76	BB518	79
16600550	79	BA815-CSU	76	BB519	79
16600568	79	BA815SU	76	BB520	79
16600576	79	BA818SU	76	BB521	79
16600584	79	BA819SU	77	BB522	79
16600592	79	BA820SU	77	BB523	79
16615514	79	BA821SU	77	BB524	79
16615522	79	BA822SU	77	BB525	79
16616634	79	BA823SU	77	BB536	79
		BA824SU	77	BB540	79
BA210	81	BA825SU	77	BB542	79
BA211	81	BA836SU	77	BC324SU	71
BA212	81	BB060R	83	BD222SU	71

Art. No Art.-Nr.	Page Seite	Art. No Art.-Nr.	Page Seite	Art. No Art.-Nr.	Page Seite
BM235SU	71	EK134SU	26	FB226R	37
		EK136SU	26	FB227R	37
EJ022SU	5, 57	EK138SU	26	FB234R	37
EJ023SU	5, 57	EK148SU	24	FB235R	37
EJ024SU	57	EK149SU	5, 24	FB236R	37
EJ025SU	57	EK150SU	24	FB238R	37
EJ571P	43	EK159SU	25	FB239R	37
EJ870P	43	EK160SU	25	FB240R	37
EJ871R	43	EK169SU	26	FB242R	37
EJ872R	43	EK170SU	26	FB245R	37
EJ873R	43	EK210SU	23	FB246R	37
EJ995	5, 55	EK212SU	23	FB248R	37
EJ996	55	EK214SU	23	FB249R	37
EK001SU	5, 27	EK216SU	23	FB251R	37
EK002SU	5, 27	EK218SU	23	FB252R	37
EK030R	29	EK224SU	25	FB253R	37
EK105SU	29	EK226SU	5, 25	FB254R	37
EK110SU	24	EK228SU	25	FB255R	37
EK111SU	24	EK230SU	27	FB282R	37
EK112SU	24	EK234SU	26	FC171R	33
EK113SU	24	EK236SU	26	FC174R	33
EK114SU	24	EK238SU	26	FC175R	33
EK115SU	24	EK240SU	27	FC177R	33
EK116SU	24	EV2-000055	59	FC178R	33
EK117SU	5, 24	EV2-000056	59	FC179R	33
EK118SU	24			FC181R	33
EK124SU	25	FB222R	37	FC184R	33
EK126SU	5, 25	FB223R	37	FC185R	33
EK128SU	25	FB224R	37	FC187R	33

ENDOSCOPIC INSTRUMENTS AND ACCESSORIES

ENDOSKOPISCHE INSTRUMENTE UND ZUBEHÖR

Index

Art. No Art.-Nr.	Page Seite	Art. No Art.-Nr.	Page Seite	Art. No Art.-Nr.	Page Seite
FC188R	33	GK164R	67	PG043SU	53
FC191R	33	GK165R	67	PG072SU	47
FC194R	33	GK290SU	19	PG073SU	47
FC195R	33	GK291SU	19	PG074SU	47
FC196R	33	GK292SU	19	PG075SU	47
FC197R	33	GK432R	69	PG096SU	55
FC198R	33	GK433R	69	PG106	55
FC199R	33	GK434R	69	PG107SU	55
FC204R	33	GK435R	69	PG122SU	49
FC205R	33	GK436R	69	PG123SU	49
FC206R	33	GN200	7	PG132SU	49
FC207R	33	GN211	67	PG133SU	49
FC208R	33	GN236	69	PG134SU	50
FC209R	33			PG135SU	50
FC214R	33	JG904	63	PG136	50
FC215R	33	JG910	63	PG137	50
FC216R	33			PG138SU	51
FC217R	33	PG012	5	PG139	51
FC218R	33	PG012	55	PL450SU	31, 33
FC219R	33	PG019	55	PL452SU	31, 33
		PG032SU	53	PL453SU	31, 33
GK080	65	PG033SU	53	PL459SU	31, 33
GK081	65	PG035SU	53	PL462SU	31, 33
GK083	65	PG036SU	5, 45	PL465SU	31, 33
GK084	65	PG037SU	45	PL468SU	31, 33
GK091	65	PG038R	53	PL471SU	31, 33
GK100	65	PG039R	53	PL475SU	5
GK101	65	PG041R	53	PL503R	37
GK107	65	PG042SU	53	PL504R	37

Art. No Art.-Nr.	Page Seite	Art. No Art.-Nr.	Page Seite	Art. No Art.-Nr.	Page Seite
PL506R	41	PL731SU	7	SK271C	43
PL508R	41	PL738SU	7		
PL512R	41	PL739SU	7		
PL528R	37	PL740SU	7		
PL561T	35, 37	PL741SU	7		
PL565T	35, 37	PL742SU	7		
PL566T	35, 37	PL743SU	7		
PL567T	35, 37	PO800SU	21		
PL568T	35, 37	PO830SU	9		
PL569T	5, 41	PO831SU	9		
PL572T	41	PO833SU	9		
PL574T	39	PO840SU	11		
PL579T	39	PO841SU	11		
PL600R	41	PO842SU	12		
PL603R	39	PO843SU	12		
PL604R	39	PO844SU	13		
PL606R	39	PO845SU	13		
PL608R	39	PO885SU	15		
PL700	19	PO886	15		
PL701	19	PO887	15		
PL702SU	19	PO888	15		
PL703SU	19	PO889	15		
PL718SU	7	PO891SU	17		
PL719SU	7	PO892SU	17		
PL720SU	7	PO893SU	17		
PL721SU	7	PO894SU	17		
PL722SU	7	PV641SU	61		
PL723SU	7	PV642SU	61		
PL730SU	7				

AESCULAP® – a B. Braun brand

Aesculap AG | Am Aesculap-Platz | 78532 Tuttlingen | Germany
Phone +49 7461 95-0 | Fax +49 7461 95-2600 | www.aesculap.com

The main product trademark "Aesculap" and the product trademarks "AdTec", "Caiman", "Challenger", "Care-Lock" and "SUSI" are registered trademarks of Aesculap AG. The product trademark "EinsteinVision" is a registered trademark of the Hebrew University of Jerusalem.

Subject to technical changes. All rights reserved. This brochure may only be used for the exclusive purpose of obtaining information about our products. Reproduction in any form partial or otherwise is not permitted.